

Programmable Controller



MELSEC iQ-F
series



MELSEC iQ-F
FX5 User's Manual (CC-Link IE)

SAFETY PRECAUTIONS

(Read these precautions before use.)

Before using this product, please read this manual and the relevant manuals introduced in this manual carefully and pay full attention to safety in order to handle the product correctly.

This manual classifies the safety precautions into two categories: [ WARNING] and [ CAUTION].

 WARNING	Indicates that incorrect handling may cause hazardous conditions, resulting in death or severe injury.
 CAUTION	Indicates that incorrect handling may cause hazardous conditions, resulting in minor or moderate injury or property damage.

Depending on the circumstances, procedures indicated by [ CAUTION] may also cause severe injury.

It is important to follow all precautions for personal safety.

Store this manual in a safe place so that it can be read whenever necessary. Always forward it to the end user.

[DESIGN PRECAUTIONS]

WARNING

- Make sure to set up the following safety circuits outside the PLC to ensure safe system operation even during external power supply problems or PLC failure. Otherwise, malfunctions may cause serious accidents.
 - Most importantly, set up the following: an emergency stop circuit, a protection circuit, an interlock circuit for opposite movements (such as normal vs. reverse rotation), and an interlock circuit to prevent damage (to the equipment at the upper and lower positioning limits).
 - Note that when the CPU module detects an error, such as a watchdog timer error, during self-diagnosis, all outputs are turned off. Also, when an error that cannot be detected by the CPU module occurs in an input/output control block, output control may be disabled. External circuits and mechanisms should be designed to ensure safe machinery operation in such a case.
 - Note that when an error occurs in a relay or transistor or triac of an output circuit, the output might stay on or off. For output signals that may lead to serious accidents, external circuits and mechanisms should be designed to ensure safe machinery operation in such a case.
 - In an output circuit, when a load current exceeding the current rating or an overcurrent caused by a load short-circuit flows for a long time, it may cause smoke and fire. To prevent this, configure an external safety circuit, such as a fuse.
 - For the operating status of each station after a communication failure of the network, refer to relevant manuals for the network. Incorrect output or malfunction may result in an accident.
 - Construct an interlock circuit in the program so that the whole system always operates on the safe side before executing the control (for data change) of the PLC in operation.

Read the manual thoroughly and ensure complete safety before executing other controls (for program change, parameter change, forcible output and operation status change) of the PLC in operation. Otherwise, the machine may be damaged and accidents may occur due to erroneous operations.
 - Especially, in the case of a control from an external device to a remote programmable controller, immediate action cannot be taken for a problem on the programmable controller due to a communication failure. Determine the handling method as a system when communication failure occurs along with configuration of interlock circuit on a program, by considering the external equipment and CPU module.
-

WARNING

- Do not write any data to the "system area" and "write-protect area" of the buffer memory in the module. Executing data writing to the "system area" or "write protect area" may cause malfunction of the programmable controller alarm. For the "system area" or "write-protect area", refer to  Page 132 Buffer Memory.
 - If a communication cable is disconnected, the network may be unstable, resulting in a communication failure of multiple stations. Construct an interlock circuit in the program so that the system always operates on the safe side even if communications fail. Incorrect output or malfunction may result in an accident.
-

[DESIGN PRECAUTIONS]

CAUTION

- Do not bundle the control line and communication cables together with or lay them close to the main circuit or power line. As a guideline, lay the control line and communication cables at least 100 mm away from the main circuit or power line. Failure to do so may result in malfunction due to noise.
 - Simultaneously turn on and off the power supplies of the CPU module and extension modules.
-

[SECURITY PRECAUTIONS]

WARNING

- To maintain the security (confidentiality, integrity, and availability) of the programmable controller and the system against unauthorized access, denial-of-service (DoS) attacks, computer viruses, and other cyberattacks from unreliable networks and devices via network, take appropriate measures such as firewalls, virtual private networks (VPNs), and antivirus solutions.
-

[INSTALLATION PRECAUTIONS]

WARNING

- Make sure to cut off all phases of the power supply externally before attempting installation or wiring work. Failure to do so may cause electric shock or damage to the product.
 - Use the product within the generic environment specifications described in the User's Manual (Hardware) of the CPU module used.
Never use the product in areas with excessive dust, oily smoke, conductive dusts, corrosive gas (salt air, Cl₂, H₂S, SO₂ or NO₂), flammable gas, vibration or impacts, or expose it to high temperature, condensation, or rain and wind.
If the product is used in such conditions, electric shock, fire, malfunctions, deterioration or damage may occur.
-

[INSTALLATION PRECAUTIONS]

CAUTION

- Do not touch the conductive parts of the product directly. Doing so may cause device failures or malfunctions.
 - When drilling screw holes or wiring, make sure that cutting and wiring debris do not enter the ventilation slits of the PLC. Failure to do so may cause fire, equipment failures or malfunctions.
 - For the product supplied together with a dust proof sheet, the sheet should be affixed to the ventilation slits before the installation and wiring work to prevent foreign objects such as cutting and wiring debris.
However, when the installation work is completed, make sure to remove the sheet to provide adequate ventilation. Failure to do so may cause fire, equipment failures or malfunctions.
 - Install the product on a flat surface. If the mounting surface is rough, undue force will be applied to the PC board, thereby causing nonconformities.
 - Install the product securely using a DIN rail or mounting screws.
 - Work carefully when using a screwdriver such as installation of the product. Failure to do so may cause damage to the product or accidents.
 - Connect the extension cables, peripheral device cables, input/output cables and battery connecting cable securely to their designated connectors. Loose connections may cause malfunctions.
 - Turn off the power to the PLC before attaching or detaching the following devices. Failure to do so may cause device failures or malfunctions.
 - Peripheral devices, expansion board, expansion adapter, and connector conversion adapter
 - Extension modules, bus conversion module, and connector conversion module
 - Battery
-

[WIRING PRECAUTIONS]

WARNING

- Make sure to cut off all phases of the power supply externally before attempting installation or wiring work. Failure to do so may cause electric shock or damage to the product.
 - Make sure to attach the terminal cover, provided as an accessory, before turning on the power or initiating operation after installation or wiring work. Failure to do so may cause electric shock.
 - The temperature rating of the cable should be 80°C or more.
 - Make sure to wire the screw terminal block in accordance with the following precautions. Failure to do so may cause electric shock, equipment failures, a short-circuit, wire breakage, malfunctions, or damage to the product.
 - The disposal size of the cable end should follow the dimensions described in the User's Manual (Hardware) of the CPU module used.
 - Tightening torque should follow the specifications in the User's Manual (Hardware) of the CPU module used.
 - Tighten the screws using a Phillips-head screwdriver No. 2 (shaft diameter 6 mm or less). Make sure that the screwdriver does not touch the partition part of the terminal block.
-

[WIRING PRECAUTIONS]

CAUTION

- Perform class D grounding (grounding resistance: 100 Ω or less) of the grounding terminal on the CPU module and extension modules with a wire 2 mm² or thicker.
Do not use common grounding with heavy electrical systems (refer to the User's Manual (Hardware) of the CPU module used).
 - Connect the power supply wiring to the dedicated terminals described in this manual. If an AC power supply is connected to a DC input/output terminal or DC power supply terminal, the PLC will burn out.
 - Do not wire vacant terminals externally. Doing so may damage the product.
 - Install module so that excessive force will not be applied to terminal blocks, power connectors, I/O connectors, communication connectors, or communication cables. Failure to do so may result in wire damage/breakage or PLC failure.
 - Make sure to observe the following precautions in order to prevent any damage to the machinery or accidents due to malfunction of the PLC caused by abnormal data written to the PLC due to the effects of noise:
 - Do not bundle the power line, control line and communication cables together with or lay them close to the main circuit, high-voltage line, load line or power line. As a guideline, lay the power line, control line and connection cables at least 100 mm away from the main circuit, high-voltage line, load line or power line.
 - Ground the shield of the shielded wire or shield cable at one point on the PLC. However, do not use common grounding with heavy electrical systems.
-

[STARTUP AND MAINTENANCE PRECAUTIONS]

WARNING

- Do not touch any terminal while the PLC's power is on. Doing so may cause electric shock or malfunctions.
 - Before cleaning or retightening terminals, cut off all phases of the power supply externally. Failure to do so in the power ON status may cause electric shock.
 - Before modifying the program in operation, forcible output, running or stopping the PLC, read through this manual carefully, and ensure complete safety. An operation error may damage the machinery or cause accidents.
 - Do not change the program in the PLC from two or more peripheral equipment devices at the same time. (i. e. from an engineering tool and a GOT) Doing so may cause destruction or malfunction of the PLC program.
-

[STARTUP AND MAINTENANCE PRECAUTIONS]

CAUTION

- Do not disassemble or modify the PLC. Doing so may cause fire, equipment failures, or malfunctions. For repair, contact your local Mitsubishi Electric representative.
 - Turn off the power to the PLC before connecting or disconnecting any extension cable. Failure to do so may cause device failures or malfunctions.
 - Turn off the power to the PLC before attaching or detaching the following devices. Failure to do so may cause device failures or malfunctions.
 - Peripheral devices, expansion board, expansion adapter, and connector conversion adapter
 - Extension modules, bus conversion module, and connector conversion module
 - Battery
-

[OPERATION PRECAUTIONS]

CAUTION

- Construct an interlock circuit in the program so that the whole system always operates on the safe side before executing the control (for data change) of the PLC in operation. Read the manual thoroughly and ensure complete safety before executing other controls (for program change, parameter change, forcible output and operation status change) of the PLC in operation. Otherwise, the machine may be damaged and accidents may occur by erroneous operations.
 - Note that the whole system may not be reset by the RUN/STOP/RESET switch when the CPU module or intelligent function module detects an error, such as a watchdog timer error, during self-diagnosis. In that case, turn off and on the power.
-

[DISPOSAL PRECAUTIONS]

CAUTION

- Please contact a certified electronic waste disposal company for the environmentally safe recycling and disposal of your device.
-

[TRANSPORTATION PRECAUTIONS]

CAUTION

- The PLC is a precision instrument. During transportation, avoid impacts larger than those specified in the general specifications of the User's Manual (Hardware) of the CPU module used by using dedicated packaging boxes and shock-absorbing pallettes. Failure to do so may cause failures in the PLC. After transportation, verify operation of the PLC and check for damage of the mounting part, etc.
-

INTRODUCTION

This manual contains text, diagrams and explanations which will guide the reader in the correct installation, safe use and operation of the CC-Link IE Field Network module of MELSEC iQ-F series and should be read and understood before attempting to install or use the module.

Always forward it to the end user.

Regarding use of this product

- This product has been manufactured as a general-purpose part for general industries, and has not been designed or manufactured to be incorporated in a device or system used in purposes related to human life.
- Before using the product for special purposes such as nuclear power, electric power, aerospace, medicine or passenger movement vehicles, consult Mitsubishi Electric.
- This product has been manufactured under strict quality control. However when installing the product where major accidents or losses could occur if the product fails, install appropriate backup or failsafe functions in the system.

Note

- If in doubt at any stage during the installation of the product, always consult a professional electrical engineer who is qualified and trained in the local and national standards. If in doubt about the operation or use, please consult the nearest Mitsubishi Electric representative.
- Since the examples indicated by this manual, technical bulletin, catalog, etc. are used as a reference, please use it after confirming the function and safety of the equipment and system. Mitsubishi Electric will accept no responsibility for actual use of the product based on these illustrative examples.
- This manual content, specification etc. may be changed, without a notice, for improvement.
- The information in this manual has been carefully checked and is believed to be accurate; however, if you notice a doubtful point, an error, etc., please contact the nearest Mitsubishi Electric representative. When doing so, please provide the manual number given at the end of this manual.

MEMO

CONTENTS

SAFETY PRECAUTIONS	1
INTRODUCTION	6
RELEVANT MANUALS	10
TERMS	11
CHAPTER 1 OUTLINE	13
CHAPTER 2 SPECIFICATIONS	14
2.1 General Specifications	14
2.2 Power Supply Specifications	14
2.3 Performance Specifications	14
2.4 Part Names	15
LED display	16
CHAPTER 3 PROCEDURES BEFORE OPERATION	17
CHAPTER 4 FUNCTIONS	18
4.1 Function List	18
4.2 Cyclic Transmission	19
Data flow and link device assignment	19
Link refresh	21
Cyclic data integrity assurance	22
Input and output status settings when failure occurs	26
Output status setting for CPU STOP	27
Output status setting for CPU stop error	27
Cyclic transmission stop and restart	27
4.3 Transient Transmission	28
Communications within the same network	28
Communications with different networks	28
4.4 Interrupt Request to CPU Module	29
CHAPTER 5 SYSTEM CONFIGURATION	30
5.1 CC-Link IE Field Network Configuration	30
5.2 Precautions for System Configuration	32
CHAPTER 6 WIRING	33
6.1 Power Supply Wiring	33
Grounding	33
6.2 Wiring of CC-Link IE Field Network	34
CHAPTER 7 PARAMETER SETTINGS	36
7.1 Setting Parameters	36
7.2 Required Settings	36
Network Number	37
Station Number	37
Parameter Setting Method	37
7.3 Basic Settings	38
Refresh setting	38

7.4	Application Settings	40
	Supplementary Cyclic Settings	40
	Interrupt Settings	41
	Parameter Name	43
	Module Operation Mode	43
CHAPTER 8 DEDICATED INSTRUCTION		44
8.1	Precautions for Dedicated Instructions	46
8.2	Link Dedicated Instructions	47
	Reading data from the programmable controller on another station	47
	Reading data from the programmable controller on another station (with notification)	55
	Writing data to the programmable controller on another station	61
	Writing data to the programmable controller on another station (with notification)	70
	Sending data to the programmable controller on another station	77
	Receiving data from the programmable controller on another station	88
8.3	Other Instructions	94
	Setting parameters	94
	Setting the station number to own station	100
CHAPTER 9 PROGRAMMING		105
9.1	Procedure for Creating Programs	105
CHAPTER 10 TROUBLESHOOTING		110
10.1	Checking with LEDs	110
10.2	Checking the Module Status	113
10.3	Checking the Network Status	114
10.4	Troubleshooting for Each Symptom	118
10.5	List of Error Codes	120
10.6	List of Parameter Numbers	129
APPENDIX		130
Appendix 1 Standards		130
	Certification of UL, cUL standards	130
	Compliance with EC directive (CE Marking)	130
	Requirement for compliance with EMC directive	130
	Caution for compliance with EC Directive	131
Appendix 2 Buffer Memory		132
	List of buffer memory addresses	132
	Details of buffer memory addresses	133
Appendix 3 List of Link Special Relay (SB)		135
Appendix 4 List of Link Special Register (SW)		139
Appendix 5 Processing Time		142
	I/O response time	142
	FROM/TO processing time	142
Appendix 6 Added and Changed Functions		143
INDEX		144
REVISIONS		146
WARRANTY		147
TRADEMARKS		148

RELEVANT MANUALS

Manual name <manual number>	Description
MELSEC iQ-F FX5 User's Manual (Startup) <JY997D58201>	Describes the performance specifications, procedures before operation, and troubleshooting of the FX5 CPU module.
MELSEC iQ-F FX5UJ User's Manual (Hardware) <SH-082206ENG>	Describes the details of hardware of the FX5UJ CPU module, including input/output specifications, wiring, installation, and maintenance.
MELSEC iQ-F FX5U User's Manual (Hardware) <JY997D55301>	Describes the details of hardware of the FX5U CPU module, including input/output specifications, wiring, installation, and maintenance.
MELSEC iQ-F FX5UC User's Manual (Hardware) <JY997D61401>	Describes the details of hardware of the FX5UC CPU module, including input/output specifications, wiring, installation, and maintenance.
MELSEC iQ-F FX5 User's Manual (Application) <JY997D55401>	Describes the basic knowledge required for program design, functions of the CPU module, devices/labels, and parameters.
MELSEC iQ-F FX5 Programming Manual (Program Design) <JY997D55701>	Describes the specifications of ladder, ST, FBD/LD, and SFC programs, and labels.
MELSEC iQ-F FX5 Programming Manual (Instructions, Standard Functions/Function Blocks) <JY997D55801>	Describes the specifications of instructions and functions that can be used in programs.
MELSEC iQ-F FX5 User's Manual (Serial Communication) <JY997D55901>	Describes the N:N network, Parallel link, MELSEC Communication protocol, inverter communication, non-protocol communication, and predefined protocol support.
MELSEC iQ-F FX5 User's Manual (MELSEC Communication Protocol) <JY997D60801>	Explains methods for the device that is communicating with the CPU module by MC protocol to read and write the data of the CPU module.
MELSEC iQ-F FX5 User's Manual (MODBUS Communication) <JY997D56101>	Describes the MODBUS serial communication and MODBUS/TCP communication.
MELSEC iQ-F FX5 User's Manual (PROFIBUS) <SH-081910ENG>	Describes the PROFIBUS-DP master module.
MELSEC iQ-F FX5 User's Manual (Ethernet Communication) <JY997D56201>	Describes the Ethernet communication function of the CPU module built-in and the Ethernet module.
MELSEC iQ-F FX5-ENET User's Manual <SH-082026ENG>	Describes the FX5-ENET.
MELSEC iQ-F FX5-ENET/IP User's Manual <SH-082027ENG>	Describes the FX5-ENET/IP.
MELSEC iQ-F FX5 User's Manual (BACnet) <SH-082218ENG>	BACnet functions of the Ethernet module.
MELSEC iQ-F FX5 User's Manual (SLMP) <JY997D56001>	Explains methods for the device that is communicating with the CPU module by SLMP to read and write the data of the CPU module.
MELSEC iQ-F FX5 User's Manual (CC-Link IE TSN) <SH-082215ENG>	Describes the CC-Link IE TSN module.
MELSEC iQ-F FX5 User's Manual (CC-Link IE) <JY997D64201> (This manual)	Describes the CC-Link IE field network module.
MELSEC iQ-F FX5 User's Manual (CC-Link) <SH-081793ENG>	Describes the CC-Link system master/intelligent device module.
MELSEC iQ-F FX5 User's Manual (AnyWireASLINK) <SH-081796ENG>	Describes the AnyWireASLINK system master module.
MELSEC iQ-F FX5 User's Manual (Positioning Control - CPU module built-in, High-speed pulse input/output module) <JY997D56301>	Describes the positioning function of the CPU module built-in and the high-speed pulse input/output module.
MELSEC iQ-F FX5 User's Manual (Positioning Control - Intelligent function module) <SH-081805ENG>	Describes the positioning module.
MELSEC iQ-F FX5 Motion Module/Simple Motion Module User's Manual (Startup) <IB0300251>	Describes the specifications, procedures before operation, system configuration, wiring, and operation examples of the Motion module/Simple Motion module.
MELSEC iQ-F FX5 Motion Module/Simple Motion Module User's Manual (Application) <IB0300253>	Describes the functions, input/output signals, buffer memories, parameter settings, programming, and troubleshooting of the Motion module/Simple Motion module.
MELSEC iQ-F FX5 Motion Module/Simple Motion Module User's Manual (Advanced Synchronous Control) <IB0300255>	Describes the functions and programming for the synchronous control of the Motion module/Simple Motion module.
MELSEC iQ-F FX5 Motion Module User's Manual (CC-Link IE TSN) <IB0300568>	Describes the functions, parameter settings, troubleshooting, and buffer memories of the CC-Link IE TSN network.

Manual name <manual number>	Description
MELSEC iQ-F FX5 User's Manual (Analog Control - CPU module built-in, Expansion adapter) <JY997D60501>	Describes the analog function of the CPU module built-in and the analog adapter.
MELSEC iQ-F FX5 User's Manual (Analog Control - Intelligent function module) <SH-081802ENG>	Describes the analog input module, analog output module, and multiple input module.
MELSEC iQ-F FX5 User's Manual (Temperature Control) <SH-081799ENG>	Describes the temperature control module.
MELSEC iQ-F FX5 User's Manual (Safety Control) <SH-082078ENG>	Describes the safety extension modules.
GX Works3 Operating Manual <SH-081215ENG>	Describes the system configuration, parameter settings, and online operations of GX Works3.
Transition from MELSEC FX3G, FX3U, FX3UC Series to MELSEC iQ-F Series Handbook <JY997D66201>	Describes the transition from MELSEC FX3G/FX3U/FX3UC series to MELSEC iQ-F series.

TERMS

Unless otherwise specified, this manual uses the following terms.

For details on the FX3 devices that can be connected with the FX5, refer to the User's Manual (Hardware) of the CPU module to be used.

Terms	Description
■Devices	
FX5	Generic term for FX5UJ, FX5U and FX5UC PLCs
FX3	Generic term for FX3S, FX3G, FX3GC, FX3U, and FX3UC PLCs
FX5 CPU module	Generic term for FX5UJ CPU module, FX5U CPU module and FX5UC CPU module
FX5UJ CPU module	Generic term for FX5UJ-24MR/ES, FX5UJ-24MT/ES, FX5UJ-24MT/ESS, FX5UJ-40MR/ES, FX5UJ-40MT/ES, FX5UJ-40MT/ESS, FX5UJ-60MR/ES, FX5UJ-60MT/ES, and FX5UJ-60MT/ESS
FX5U CPU module	Generic term for FX5U-32MR/ES, FX5U-32MT/ES, FX5U-32MT/ESS, FX5U-64MR/ES, FX5U-64MT/ES, FX5U-64MT/ESS, FX5U-80MR/ES, FX5U-80MT/ES, FX5U-80MT/ESS, FX5U-32MR/DS, FX5U-32MT/DS, FX5U-32MT/DSS, FX5U-64MR/DS, FX5U-64MT/DS, FX5U-64MT/DSS, FX5U-80MR/DS, FX5U-80MT/DS, and FX5U-80MT/DSS
FX5UC CPU module	Generic term for FX5UC-32MT/D, FX5UC-32MT/DSS, FX5UC-64MT/D, FX5UC-64MT/DSS, FX5UC-96MT/D, FX5UC-96MT/DSS, FX5UC-32MT/DS-TS, FX5UC-32MT/DSS-TS, and FX5UC-32MR/DS-TS
Extension module	Generic term for FX5 extension modules, FX3 function modules, Extension modules (extension cable type) and Extension module (extension connector type)
FX5 extension module	Generic term for I/O modules, FX5 extension power supply modules, FX5 intelligent function modules, and FX5 safety extension modules
FX3 extension module	Generic term for FX3 extension power supply module and FX3 intelligent function module
Extension module (extension cable type)	Generic term for Input modules (extension cable type), Output modules (extension cable type), Input/output modules (extension cable type), Powered input/output module, High-speed pulse input/output module, Extension power supply module (extension cable type), Connector conversion module (extension cable type), Intelligent function modules, Safety extension modules, and Bus conversion module (extension cable type)
Extension module (extension connector type)	Generic term for Input modules (extension connector type), Output modules (extension connector type), Input/output modules (extension connector type), Extension power supply module (extension connector type), Connector conversion module (extension connector type), and Bus conversion module (extension connector type)
I/O module	Generic term for Input modules, Output modules, Input/output modules, Powered input/output modules, and High-speed pulse input/output modules
Input module	Generic term for Input modules (extension cable type) and Input modules (extension connector type)
Input module (extension cable type)	Generic term for FX5-8EX/ES and FX5-16EX/ES
Input module (extension connector type)	Generic term for FX5-C16EX/D, FX5-C16EX/DS, FX5-C32EX/D, FX5-C32EX/DS, and FX5-C32EX/DS-TS
Output module	Generic term for Output modules (extension cable type) and Output modules (extension connector type)
Output module (extension cable type)	Generic term for FX5-8EYR/ES, FX5-8EYT/ES, FX5-8EYT/ESS, FX5-16EYR/ES, FX5-16EYT/ES, and FX5-16EYT/ESS
Output module (extension connector type)	Generic term for FX5-C16EYT/D, FX5-C16EYT/DSS, FX5-C16EYR/D-TS, FX5-C32EYT/D, FX5-C32EYT/DSS, FX5-C32EYT/D-TS, and FX5-C32EYT/DSS-TS
Input/output module	Generic term for Input/output modules (extension cable type) and Input/output modules (extension connector type)
Input/output module (extension cable type)	Generic term for FX5-16ER/ES, FX5-16ET/ES, and FX5-16ET/ESS

Terms	Description
Input/output module (extension connector type)	Generic term for FX5-C32ET/D, FX5-C32ET/DSS, FX5-C32ET/DS-TS, and FX5-C32ET/DSS-TS
Powered input/output module	Generic term for FX5-32ER/ES, FX5-32ET/ES, FX5-32ET/ESS, FX5-32ER/DS, FX5-32ET/DS, and FX5-32ET/DSS
High-speed pulse input/output module	Generic term for FX5-16ET/ES-H and FX5-16ET/ESS-H
Extension power supply module	Generic term for FX5 extension power supply module and FX3 extension power supply module
FX5 extension power supply module	Generic term for FX5 extension power supply module (extension cable type) and FX5 extension power supply module (extension connector type)
FX5 extension power supply module (extension cable type)	Different name for FX5-1PSU-5V
FX5 extension power supply module (extension connector type)	Different name for FX5-C1PS-5V
FX3 extension power supply module	Different name for FX3U-1PSU-5V
Intelligent module	The abbreviation for intelligent function modules
Intelligent function module	Generic term for FX5 intelligent function modules and FX3 intelligent function modules
FX5 intelligent function module	Generic term for FX5-4AD, FX5-4DA, FX5-8AD, FX5-4LC, FX5-20PG-P, FX5-20PG-D, FX5-40SSC-G, FX5-80SSC-G, FX5-40SSC-S, FX5-80SSC-S, FX5-ENET, FX5-ENET/IP, FX5-CCLGN-MS, FX5-CCLIEF, FX5-CCL-MS, FX5-ASL-M, and FX5-DP-M
FX3 intelligent function module	Generic term for FX3U-4AD, FX3U-4DA, FX3U-4LC, FX3U-1PG, FX3U-2HC, FX3U-16CCL-M, FX3U-64CCL, FX3U-128ASL-M, and FX3U-32DP
FX5 safety extension module	Generic term for safety main modules and safety expansion modules
Safety main module	Different name for FX5-SF-MU4T5
Safety expansion module	Generic term for expansion modules installed to a safety main module
Safety input expansion module	Different name for FX5-SF-8DI4
Expansion board	Generic term for board for FX5UJ CPU module and FX5U CPU module
Communication board	Generic term for FX5-232-BD, FX5-485-BD, and FX5-422-BD-GOT
Expansion adapter	Generic term for adapter for FX5 CPU module
Communication adapter	Generic term for FX5-232ADP and FX5-485ADP
Analog adapter	Generic term for FX5-4AD-ADP, FX5-4DA-ADP, FX5-4AD-PT-ADP, FX5-4AD-TC-ADP, and FX5-4A-ADP
Bus conversion module	Generic term for Bus conversion module (extension cable type) and Bus conversion module (extension connector type)
Bus conversion module (extension cable type)	Different name for FX5-CNV-BUS
Bus conversion module (extension connector type)	Different name for FX5-CNV-BUSC
Connector conversion module	Generic term for Connector conversion module (extension cable type) and Connector conversion module (extension connector type)
Connector conversion module (extension cable type)	Different name for FX5-CNV-IF
Connector conversion module (extension connector type)	Different name for FX5-CNV-IFC
Extended extension cable	Generic term for FX5-30EC and FX5-65EC
Connector conversion adapter	Different name for FX5-CNV-BC
Battery	Different name for FX3U-32BL
Peripheral device	Generic term for engineering tools and GOTs
GOT	Generic term for Mitsubishi Electric Graphic Operation Terminal GOT1000 and GOT2000 series
■Software packages	
Engineering tool	The product name of the software package for the MELSEC programmable controllers
GX Works3	The product name of the software package, SWnDND-GXW3, for the MELSEC programmable controllers (The 'n' represents a version.)

1 OUTLINE

- CC-Link IE Field Network is a high-speed (1 Gbps) and large-capacity open field network using Ethernet (1000BASE-T).
- The FX5-CCLIEF is the intelligent function module to connect the FX5 CPU module as an intelligent device station of CC-Link IE Field Network.
- Wiring of CC-Link IE Field Network supports line topology, star topology, and ring topology.
- Data between the FX5 CPU module and FX5-CCLIEF can be sent/received through the buffer memory using the FROM/TO instructions. Also, data can be replaced with an internal device (such as X, Y, B, W, SB, or SW) and used in a program when using the auto refresh function.

Data communication

■Cyclic transmission

Data can be periodically communicated with the master station on the same network.

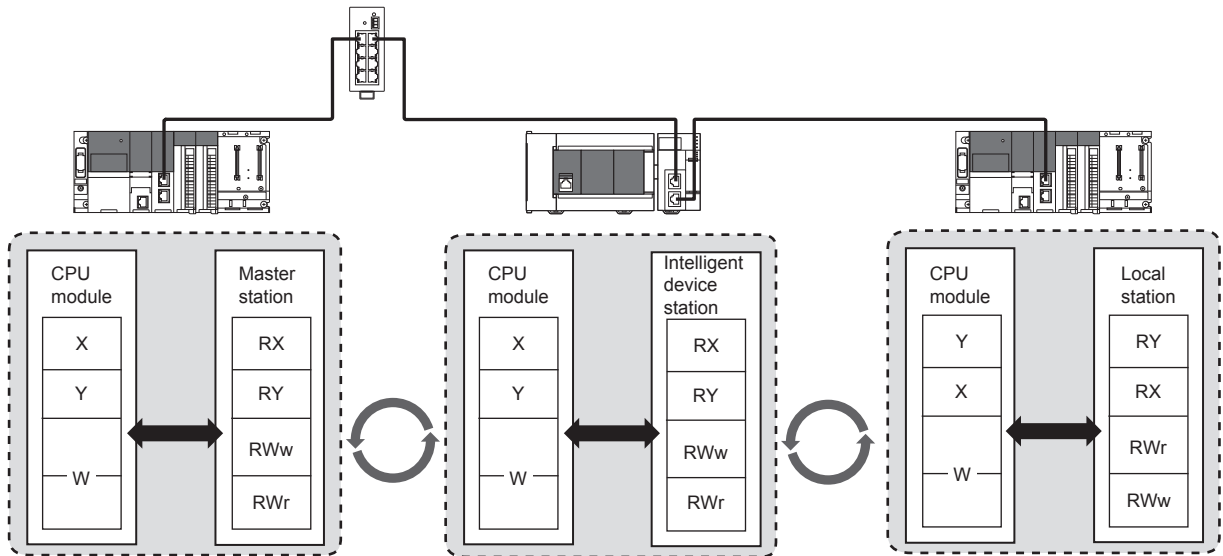

■Transient transmission

Another station programmable controller can be accessed using dedicated instructions.

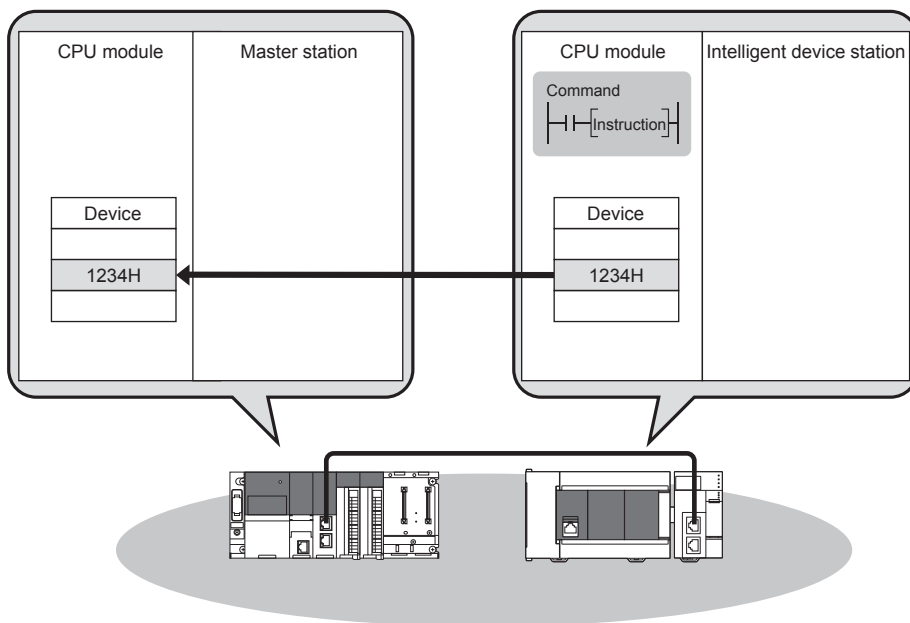

2 SPECIFICATIONS

This chapter describes the FX5-CCLIEF specifications.

2.1 General Specifications

The general specifications other than below are the same as those for the FX5 CPU module to be connected.

For general specifications, refer to the following.

📖 MELSEC iQ-F FX5UJ User's Manual (Hardware)

📖 MELSEC iQ-F FX5U User's Manual (Hardware)

📖 MELSEC iQ-F FX5UC User's Manual (Hardware)

Items	Specifications	
Dielectric withstand voltage	500 V AC for 1 minute	Between all terminals and ground terminal
Insulation resistance	10 MΩ or higher by 500 V DC insulation resistance tester	

2.2 Power Supply Specifications

The following table lists the power supply specifications.

Items	Specifications	
External power supply	Power supply voltage	24 V DC +20%/-15%
	Allowable instantaneous power failure time	Operation continues when the instantaneous power failure is shorter than 1 ms.
	Current consumption	230 mA
Internal power supply	Power supply voltage	5 V DC
	Current consumption	10 mA

2.3 Performance Specifications

The following table lists the performance specifications.

Items	Specifications	
Station type	Intelligent device station	
Station number	1 to 120 (set by parameter or program)	
Communication speed	1 Gbps	
Network topology	Line topology, star topology (coexistence of line topology and star topology is also possible), and ring topology	
Maximum station-to-station distance	100 m (conforms to ANSI/TIA/EIA-568-B (Category 5e))	
Cascade connection	Max. 20 stages	
Communication method	Token passing	
Maximum number of link points ^{*1}	RX	384 points, 48 bytes
	RY	384 points, 48 bytes
	RWr	1024 points, 2048 bytes ^{*2}
	RWw	1024 points, 2048 bytes ^{*2}
Number of occupied I/O points	8 points	
Applicable CPU module	<ul style="list-style-type: none"> FX5UJ CPU module (From the first) FX5U CPU module (Ver. 1.030 or later) FX5UC CPU module^{*3} (Ver. 1.030 or later) 	
Applicable engineering tool	<ul style="list-style-type: none"> FX5UJ CPU module: GX Works3 (Ver.1.060N or later) FX5U/FX5UC CPU module: GX Works3 (Ver.1.025B or later) 	

*1 The maximum number of points that a master station can assign to one FX5-CCLIEF unit.

*2 256 points (512 bytes) when the mode of the master station is online (high-speed mode).

*3 FX5-CNV-IFC or FX5-C1PS-5V is necessary to connect FX5-CCLIEF to the FX5UC CPU module.

2.4 Part Names

This section describes the names of each part of the FX5-CCLIEF.

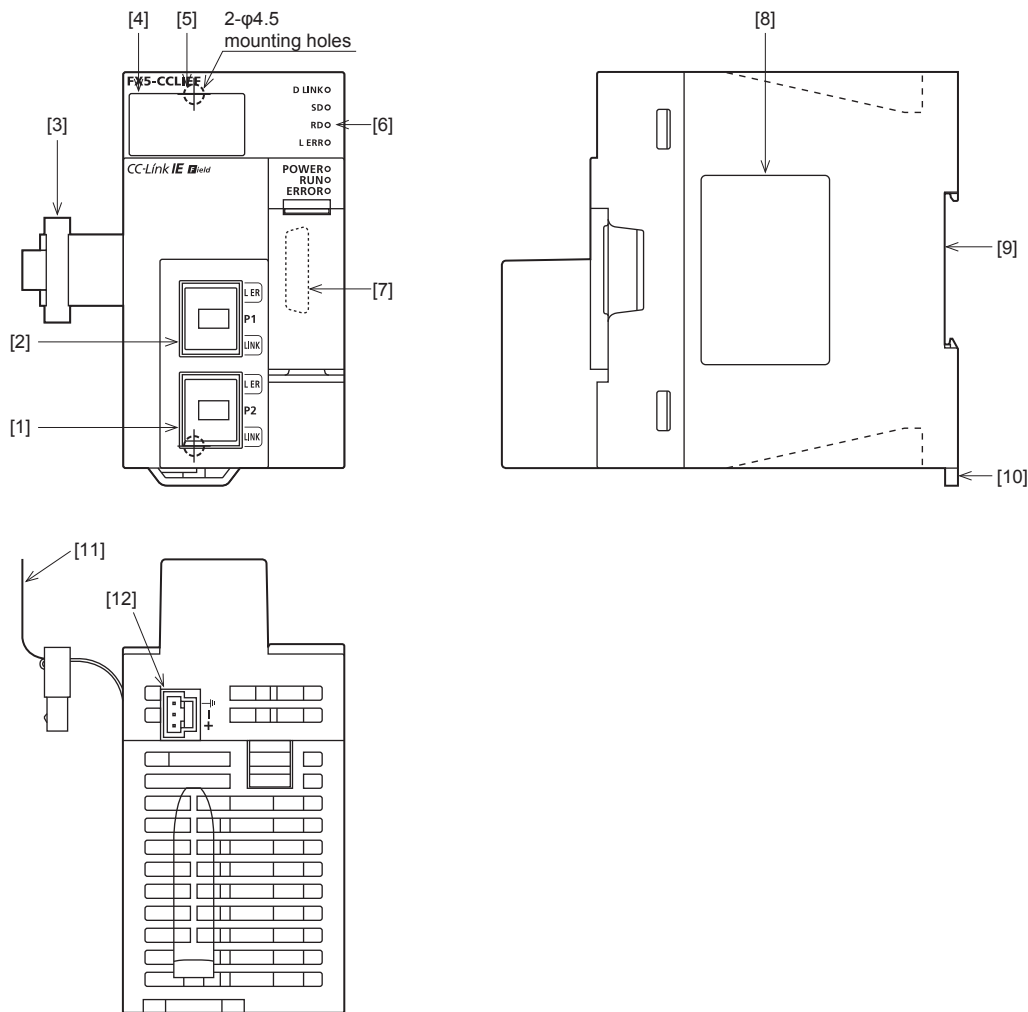

No.	Name	Description
[1]	Modular jack for P2 (RJ-45) (with cap)	PORT2 connector for CC-Link IE Field Network. Connect an Ethernet cable.
[2]	Modular jack for P1 (RJ-45) (with cap)	PORT1 connector for CC-Link IE Field Network. Connect an Ethernet cable.
[3]	Extension cable	Cable for connecting the module when adding the FX5-CCIEF
[4]	Dot matrix LED	Displays the station number set in the module and the module communication test result. For display of the module communication test result, refer to the following. (☞ Page 113 Module communication test)
[5]	Direct mounting hole	Screw holes (2-φ4.5, mounting screw: M4 screw) for direct installation
[6]	Operation status display LEDs	Indicates the operating status of the module. For details, refer to the following. (☞ Page 16 LED display)
[7]	Extension connector	Connector for connecting the extension cable of an extension module.
[8]	Nameplate	The product model name, manufacturer's serial number, power supply specifications, and MAC address are shown.
[9]	DIN rail mounting groove	The module can be installed on DIN46277 rail (35 mm wide).
[10]	DIN rail mounting hook	Hook for mounting the module on a DIN rail of DIN46277 (35 mm wide).
[11]	Pullout tab	They are used when drawing out an extension cable.
[12]	Power connector	Connector for connecting the power cable.

LED display

The following table lists the LED display.

LED display		LED color	Description
D. LINK* ¹		Green	Indicates the data link status. On: Data link (cyclic transmission being performed) Flashing: Data link (cyclic transmission stopped) Off: Data link not performed (disconnection)
SD		Green	Indicates the data sending status. On: Data being sent Off: Data not sent
RD		Green	Indicates the data receiving status. On: Data being received Off: Data not received
L. ERR		Red	Indicates the line error status. On: Error data received Off: Normal data received
POWER		Green	Indicates whether the module is powered or not. On: Power-on Off: Power-off
RUN		Green	Indicates the operating status. On: Normal operation Off: Error
ERROR* ¹		Red	Indicates the error status. On: Minor error (major error when the RUN LED turns off) Flashing: Moderate error (major error when the RUN LED turns off) Off: Normal operation
P1	LER	Red	Indicates the port status of P1. On: Error data received Off: Normal data received
	LINK	Green	Indicates the link status of P1. On: Link-up Off: Link-down
P2	LER	Red	Indicates the port status of P2. On: Error data received Off: Normal data received
	LINK	Green	Indicates the link status of P2. On: Link-up Off: Link-down
Dot matrix LED		Orange	Displays the station number set in the module and the module communication test result.

*1 The LED is always off in offline mode.

3 PROCEDURES BEFORE OPERATION

This chapter describes the procedures before operation.

1. Checking the specifications of the FX5-CCLIEF

Check the specifications of the FX5-CCLIEF. (☞ Page 14 SPECIFICATIONS)

2. Installation of the FX5-CCLIEF

Connect the FX5-CCLIEF to the FX5 CPU module. For details, refer to the following.

📖 MELSEC iQ-F FX5UJ User's Manual (Hardware)

📖 MELSEC iQ-F FX5U User's Manual (Hardware)

📖 MELSEC iQ-F FX5UC User's Manual (Hardware)

3. Wiring

Connect an Ethernet cable to the FX5-CCLIEF.

4. Checking the cable

Perform a cable test on the FX5-CCLIEF.

5. Network construction

Configure the system and set the parameters which are required for start-up.

- Wiring (☞ Page 33 WIRING)
- Parameter setting (☞ Page 36 PARAMETER SETTINGS)

6. Network diagnostics

Using network diagnostics, check if the cables are connected properly and communication is performed normally with the configured parameters.

For details, refer to the following.

(☞ Page 114 Checking the Network Status)

7. Programming

Create a program. For details, refer to the following.

(☞ Page 44 DEDICATED INSTRUCTION)

8. Debug

Debug the program by using CC-Link IE Field Network diagnostics.

4 FUNCTIONS

4.1 Function List

The following table lists the function available for the FX5-CCLIEF.

Cyclic transmission

Function		Description	Reference
Communications with the master station	Communications using RX and RY	Communicates I/O data in units of bits between the own station and master station.	Page 19
	Communications using RWr and RWw	Communicates I/O data in units of words between the own station and master station.	
Access to devices and link devices (Link refresh)		Automatically transfers data between the link device of the FX5-CCLIEF and the device of the FX5 CPU module.	Page 21
Cyclic data integrity assurance		Assures the cyclic data integrity in units of 32 bits or station-based units.	Page 22
Mode selection for cyclic transmission		Selects the mode for optimizing the performance of cyclic transmission based on the cyclic transmission and transient transmission frequency. The mode is selected from "Normal" or "High Speed". This setting is available on the master station.	—
Input status setting for data link error		Selects whether input data from the master station when a data link error occurs is cleared or held.	Page 26
Output status setting for CPU STOP		Selects whether cyclic transmission output is held or cleared when the FX5 CPU module connected to the FX5-CCLIEF is set to STOP.	Page 27
Output status setting for CPU stop error		Selects whether cyclic transmission output is held or cleared when a stop error occurs in the FX5 CPU module which the FX5-CCLIEF is connected to.	Page 27
Cyclic transmission stop and restart		Stops the cyclic data transmission during debugging and other operations. (Data reception from the master station and data sending from the own station are stopped.) Also, the stopped cyclic transmission can be restarted. Transient transmission does not stop.	Page 27

Transient transmission

Function		Description	Reference
Communications within the same network		Performs transient transmission to other stations using dedicated instructions and the engineering tool.	Page 28
Communications with different networks		Performs transient transmission seamlessly to stations on different networks using dedicated instructions.	Page 28
SLMP communication		Reads/writes a device data or program file of the FX5 CPU module from/to upper system.	—

RAS

Function		Description	Reference
Automatic return		Automatically returns the station disconnected from the network due to a data link error to the network when it recovers and restarts data link.	—

Diagnostics

Function		Description	Reference
CC-Link IE Field Network diagnostics		Checks the status of the FX5-CCLIEF using the engineering tool. The cause of error and corrective actions can be checked in the engineering tool.	Page 114
Diagnostics of the module	Module communication test	Checks the hardware of the FX5-CCLIEF. This test should be conducted when the communication is unstable.	Page 113
Diagnostics of own network	Cable Test	Checks the connection status of the Ethernet cables.	Page 117

Others

Function	Description	Reference
Interrupt request to CPU module	Checks interrupt conditions every link scan, and makes an interrupt request to the FX5 CPU module to start the interrupt program if the interrupt conditions are met.	Page 29
Station number setting using a program	Sets the station number of the FX5-CCLIEF (own station) using a program. When there are systems with the same program and network parameters (excluding the station numbers), setting the station numbers using a program allows project data items other than the station number to be the same, leading to reduced development work hours.	Page 100
Firmware update function	Updates the firmware version of the FX5-CCLIEF.	MELSEC iQ-F FX5 User's Manual (Application)

4.2 Cyclic Transmission

This function allows data to be periodically exchanged among stations on the same network using link devices.

Data flow and link device assignment

Master station and slave stations (except for local stations)

One-to-one communication is possible between the master and slave stations. The status data of the link devices (RY, RWw) of the master station is output to the external device of the slave station, and the input status information from the external device of the slave station is stored in the link devices (RX, RWr) of the master station.

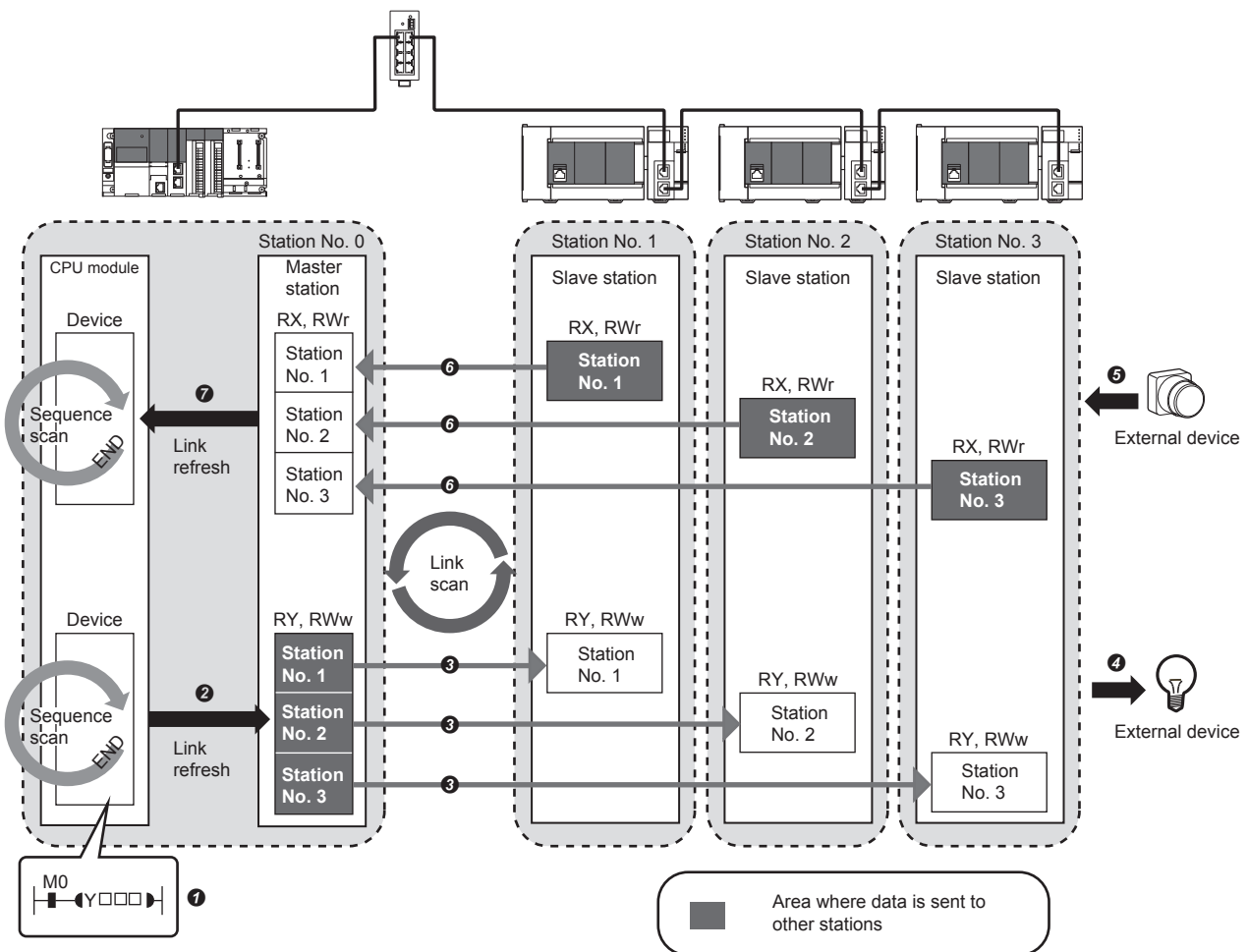

• Output from the master station

- ① The device of the CPU module turns on.
- ② The status data of the device of the CPU module are stored in the link devices (RY, RWw) of the master station by link refresh.
- ③ The status data of the link devices (RY, RWw) of the master station are stored in the link devices (RY, RWw) of each slave station by link scan.
- ④ The status data of the link devices (RY, RWw) of the slave station are output to the external device.

• Input from the slave station

- ⑤ The status data of the external device are stored in the link devices (RX, RWr) of the slave station.
- ⑥ The status data of the link devices (RX, RWr) of the slave station are stored in the link devices (RX, RWr) of the master station by link scan.
- ⑦ The status data of the link devices (RX, RWr) of the master station are stored in the devices of the CPU module by link refresh.

Coexistence of local stations and the other slave stations (other than local stations)

The data of all slave stations are also stored in the local stations in the same way as the master station.

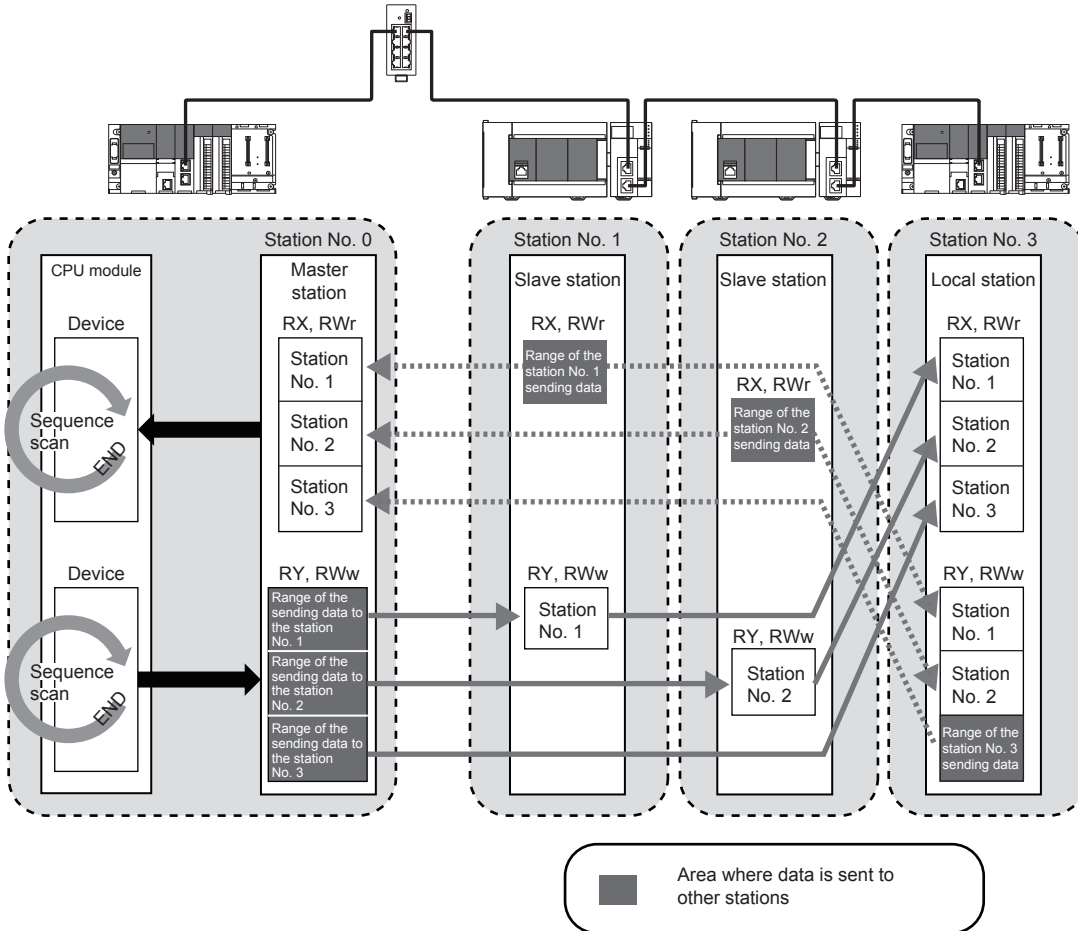

Setting method

The link refresh is assigned in "Refresh Setting" under "Basic Settings". (☞ Page 38 Refresh setting)

Link refresh

This function automatically transfers data between the link devices of the FX5-CCLIEF and the devices of the CPU module.

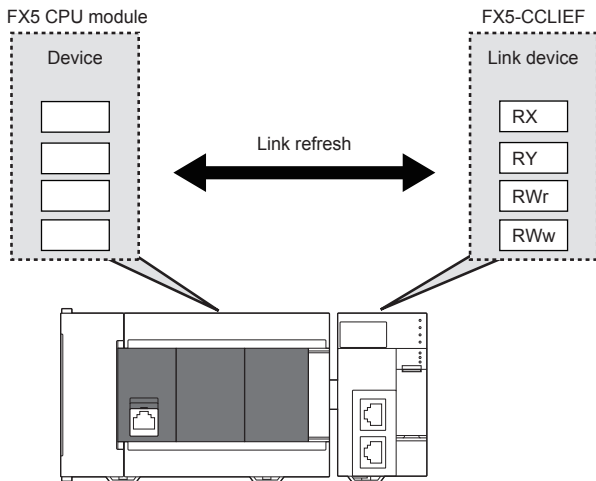

Concept of the link refresh range (number of points)

The link refresh is performed to the area set with the refresh parameters.

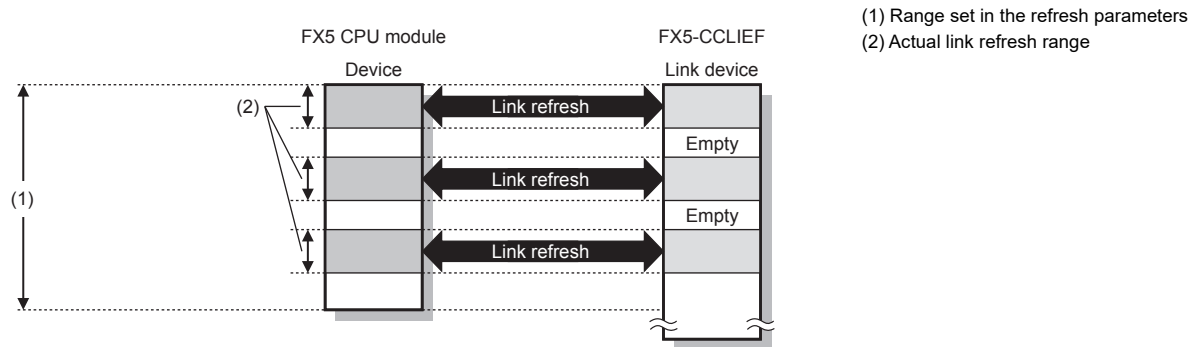

Shortening the link refresh time and transmission delay time

The link refresh time and transmission delay time can be shortened by reducing the number of link refresh points to the CPU module. To reduce the number of the link refresh points, set only the link devices used in the FX5 CPU module as the link refresh range in the refresh parameters setting. (Page 38 Refresh setting)

Setting method

The link refresh is assigned in "Refresh Setting" under "Basic Settings". (Page 38 Refresh setting)

Precautions

■ Latched devices of the FX5 CPU module

If data in latched devices of the FX5 CPU module are cleared to zero on a program when the FX5 CPU module is powered off and on or reset, the data may be output without being cleared to zero, depending on the timing of the link scan and link refresh. Take the following actions not to output the data in the latched devices.

FX5 CPU module device	How to disable the device data
Latch relay (L)	Use the initial device value of the FX5 CPU module to clear the device to zero.*1
Internal relay (M), Link relay (B), Data register (D), Link register (W), File register (R), device in the latch range	Delete all the latch range settings.*2

*1 For the initial device value setting of the FX5 CPU module, refer to the following.

MELSEC iQ-F FX5 User's Manual (Application)

*2 Only FX5U/FX5UC CPU module is supported.

Cyclic data integrity assurance

This function assures the cyclic data integrity in units of 32 bits or station-based units.

○: Assured, ×: Not assured

Method	Description	Availability	
		Link refresh	Access to buffer memory
32-bit data assurance	Assures data in 32-bit units.	○	○
Station-based block data assurance	Assures data in station-based units. Data is assured by enabling the station-based block data assurance in the parameter setting.	○	×
Interlock program	Assures data of more than 32 bits. Data is assured by performing interlocks on programs.	○	○

32-bit data assurance

The RWr and RWw data can be assured in 32-bit units.

■Data integrity assurance at the time of access to buffer memory

The integrity of 32-bit data can be assured by satisfying the following conditions.

- Access using the DMOV instruction
- The head address of the buffer memory is multiples of 2.

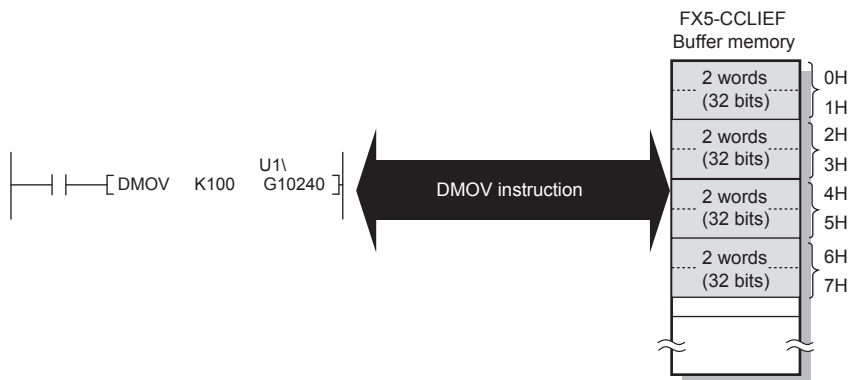

Point

For data assurance of more than 32 bits, use station-based block data assurance or interlock programs.

Station-based block data assurance

Integrity of the cyclic data is assured for each station by handshake between the FX5 CPU module and FX5-CCLIEF for a link refresh.

■Setting

Enable "Station-based Block Data Assurance per Station" in the parameter settings of the master station.

Once this setting is enabled on the master station, integrity of the data for all stations is assured for each station.

For the setting method, refer to the manual for the master station module used.

Access to link devices

During a link refresh, data are assured for each station as shown below.

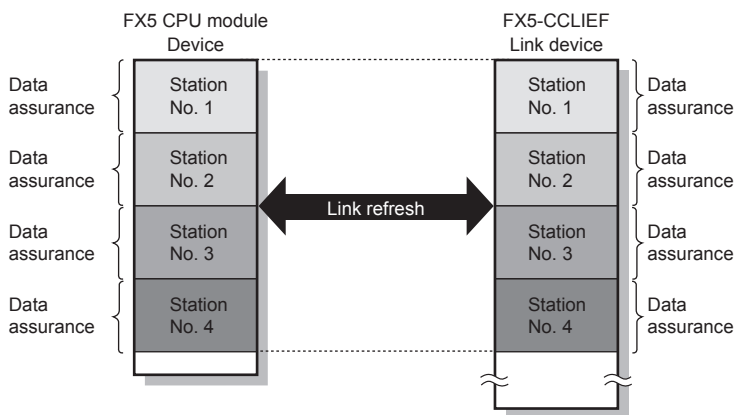

Interlock program

Data of more than 32 bits can be assured with the station-based block data assurance setting disabled. Use either of the following methods.

- Interlock using RX and RY
- Interlock using RWr and RWw (when RX, RY cannot be used as an interlock device)

Example of interlock using RX and RY

An example of sending data in W0 to W3 of the master station (station No. 0) to W1000 to W1003 of the slave station (station No. 1) is shown below. (B0 and B1000 are used for a handshake to the CPU module.)

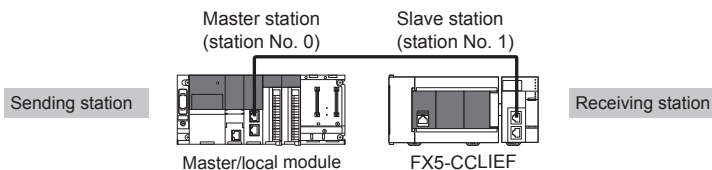

Data flow

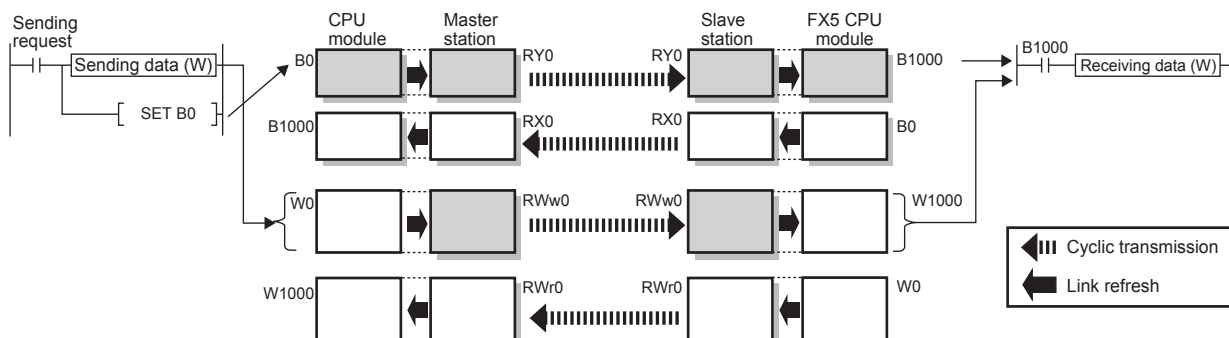

• Program

Sending station: Master station (station No. 0)

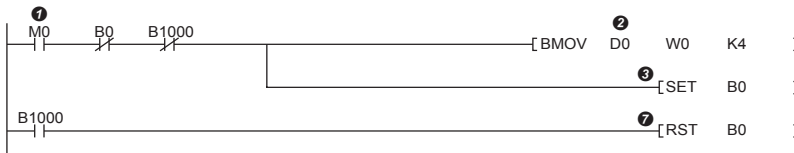

Receiving station: Slave station (station No. 1)

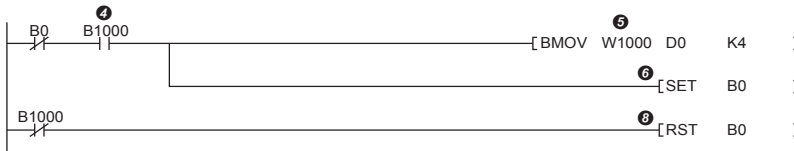

• Program flow

- ① Sending station: 'Start direction' (M0) is turned on.
- ② Sending station: The contents of 'Transfer source' (D0 to D3) are stored in W0 to W3.
- ③ Sending station: Upon completion of storage in W0 to W3, turn on B0 of the sending station for a handshake.
- ④ Receiving station: Cyclic transmission sends RWw followed by RY, and B1000 of the receiving station turns on.
- ⑤ Receiving station: The contents of W1000 to W1003 are stored in 'Transfer destination' (D0 to D3).
- ⑥ Receiving station: Upon completion of storage in 'Transfer destination' (D0 to D3), turn on B0 of the receiving station for a handshake.
- ⑦ Sending station: When B1000 of the sending station turns on, turn off B0 of the sending station.
- ⑧ Receiving station: When B1000 of the receiving station turns off, turn off B0 of the receiving station.

■ Example of interlock using RWr and RWw

An example of sending data in W0 to W3 of the master station (station No. 0) to W1000 to W1003 of the slave station (station No. 1) is shown below. This is a method used when RX and RY cannot be used as interlock devices. (B0 and B1000 are used for a handshake to the CPU module.)

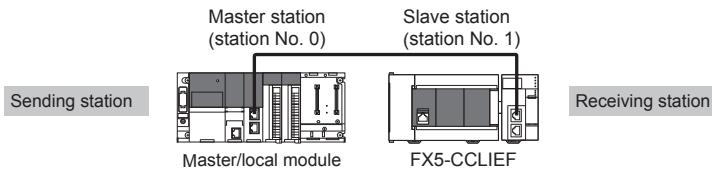

• Data flow

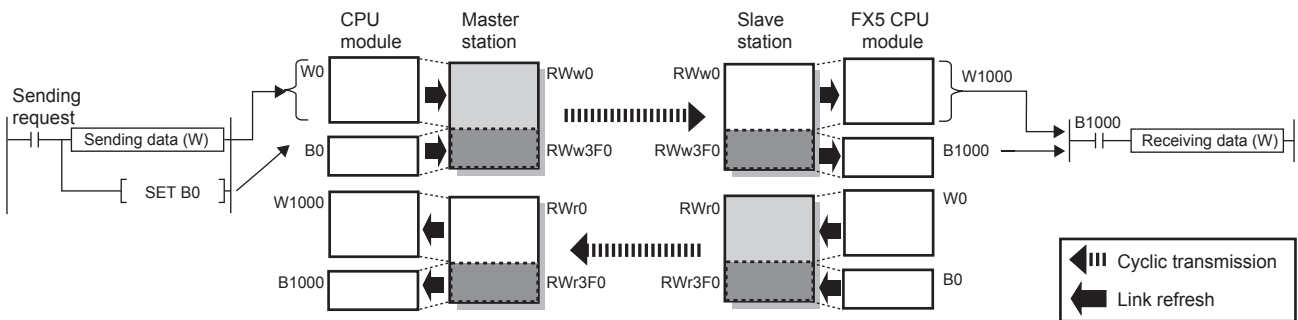

• Program

Sending station: Master station (station No. 0)

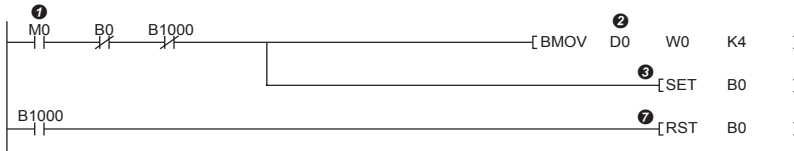

Receiving station: Slave station (station No. 1)

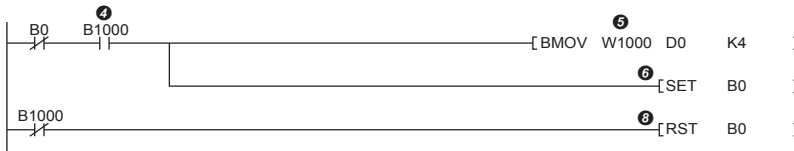

• Program flow

- ① Sending station: 'Start direction' (M0) is turned on.
- ② Sending station: The contents of 'Transfer source' (D0 to D3) are stored in W0 to W3.
- ③ Sending station: Upon completion of storage in W0 to W3, turn on B0 of the sending station for a handshake.
- ④ Receiving station: Cyclic transmission sends RWw0 to RWw3EF followed by RWw3F0, RWw0 to RWw3EF is stored firstly and RWw3F0 is stored secondly in the receiving station, and B1000 of the receiving station turns on.
- ⑤ Receiving station: The contents of W1000 to W1003 are stored in 'Transfer destination' (D0 to D3).
- ⑥ Receiving station: Upon completion of storage in 'Transfer destination' (D0 to D3), turn on B0 of the receiving station for a handshake.
- ⑦ Sending station: When B1000 of the sending station turns on, turn off B0 of the sending station.
- ⑧ Receiving station: When B1000 of the receiving station turns off, turn off B0 of the receiving station.

Input and output status settings when failure occurs

For the FX5-CCLIEF, status of input from the master station when a data link error occurs and output status of cyclic data if a stop error occurs in the FX5 CPU module can be set.

Status	Description
Input status for data link error	Whether input data from the master station when a data link error occurs is cleared or held can be selected. The RWw data are held regardless of the setting.
Cyclic data output status when a stop error occurs in the CPU module	When a stop error occurs in the FX5 CPU module, whether the RX of the FX5-CCLIEF is held or cleared can be selected. The RWr data are held regardless of the setting.

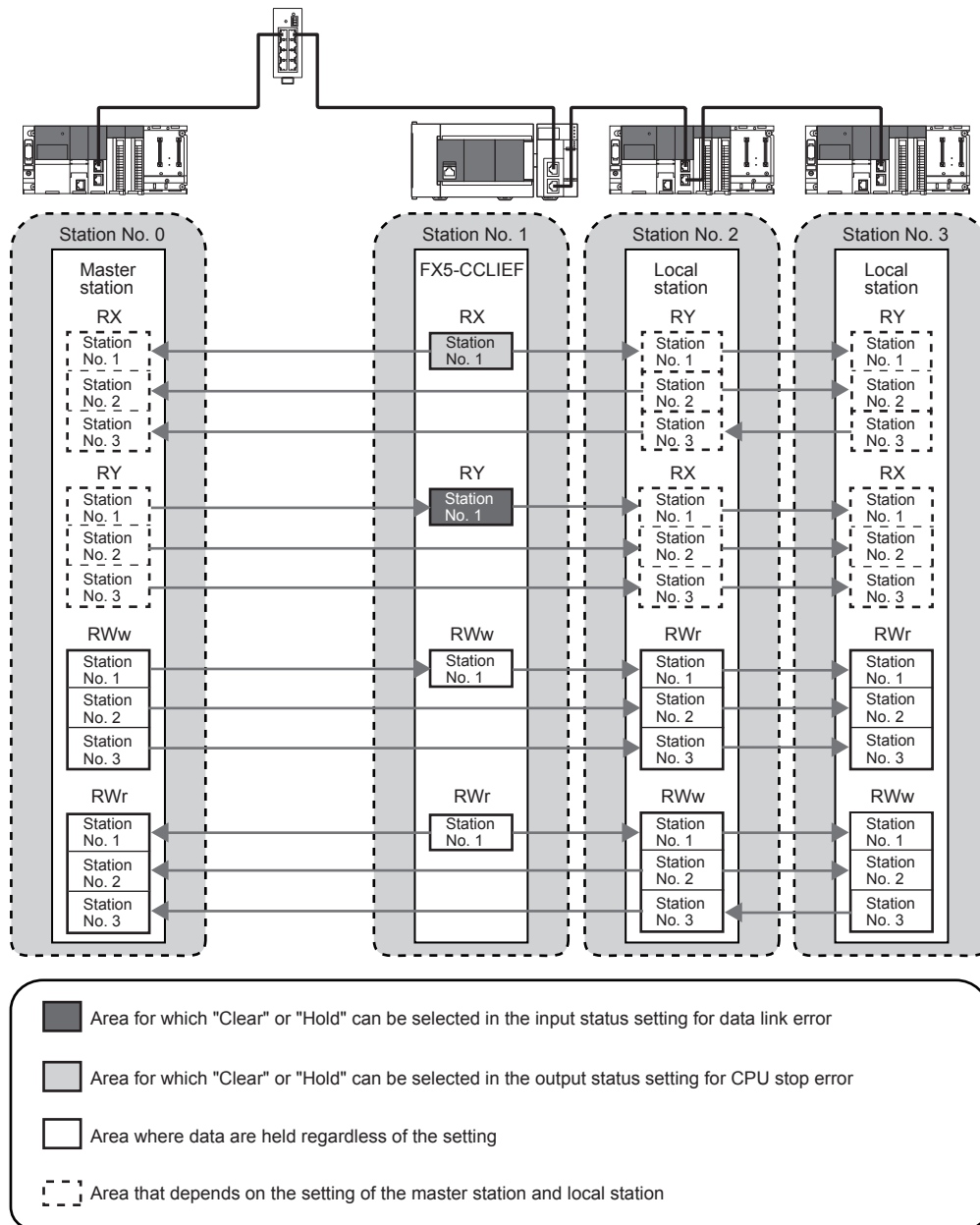

Setting method

■ Input status of data link faulty station

Set the input status of data link faulty stations under "Supplementary Cyclic Settings" in "Application Settings". (Page 40 Supplementary Cyclic Settings)

■Cyclic data output when a stop error occurs in the FX5 CPU module

Under "Supplementary Cyclic Settings" in "Application Settings", set the cyclic data output status for when a stop error occurs in the FX5 CPU module. ( Page 40 Supplementary Cyclic Settings)

Precautions

■When data link is stopped by user

When cyclic transmission is stopped using the link special relay (SB), the input status of the faulty station is held. ( Page 135 List of Link Special Relay (SB))

■Setting on a station with a data link error

When the following settings are set to "Hold" on the station where a data link error has occurred, the input status of the own station upon error is held, regardless of setting.

- "Output Hold/Clear Setting during CPU STOP" under "I/O Maintenance Settings" under "Supplementary Cyclic Settings" in "Application Settings"
- "Output Mode upon CPU Error" under "I/O Maintenance Settings" of "Supplementary Cyclic Settings" in "Application Settings"

Output status setting for CPU STOP

When the FX5 CPU module connected to the FX5-CCLIEF is set to STOP, whether cyclic data output is held or cleared can be selected.

Setting method

Under "Supplementary Cyclic Settings" in "Application Settings", set the output status for the case where the FX5 CPU module is set to STOP. ( Page 40 Supplementary Cyclic Settings)

Precautions

■When the setting is disabled

For RWr, the cyclic data output is held regardless of the device of the link refresh source, even if the output setting for CPU STOP is set to be cleared.

■When the output status setting for CPU STOP is set to clear

When the FX5 CPU module is in the STOP state, the forced output to other stations cannot be executed using the engineering tool.

Output status setting for CPU stop error

When a stop error occurs in the FX5 CPU module connected to the FX5-CCLIEF, whether cyclic data output is held or cleared can be selected.

Setting method

Under "Supplementary Cyclic Settings" in "Application Settings", set the output status for the case when a stop error occurs in the FX5 CPU module. ( Page 40 Supplementary Cyclic Settings)

Cyclic transmission stop and restart

This function stops the cyclic transmission during debugging and other operations. (Data reception from the master station and data sending from the own station are stopped.) Also, the stopped cyclic transmission can be restarted. Transient transmission does not stop.

Cyclic transmission is stopped and restarted using the link start/stop of the link special relay (SB). ( Page 135 List of Link Special Relay (SB))

4.3 Transient Transmission

This function allows communications with other stations when a request is made by a method such as a dedicated instruction or engineering tool. Communications with different networks is also possible.

Communications within the same network

This function performs transient transmission to other stations using dedicated instructions and the engineering tool. For details on dedicated instructions, refer to the following.

(👉 Page 44 DEDICATED INSTRUCTION)

Ex.

Accessing another station programmable controller using the dedicated instruction (GP.READ instruction)

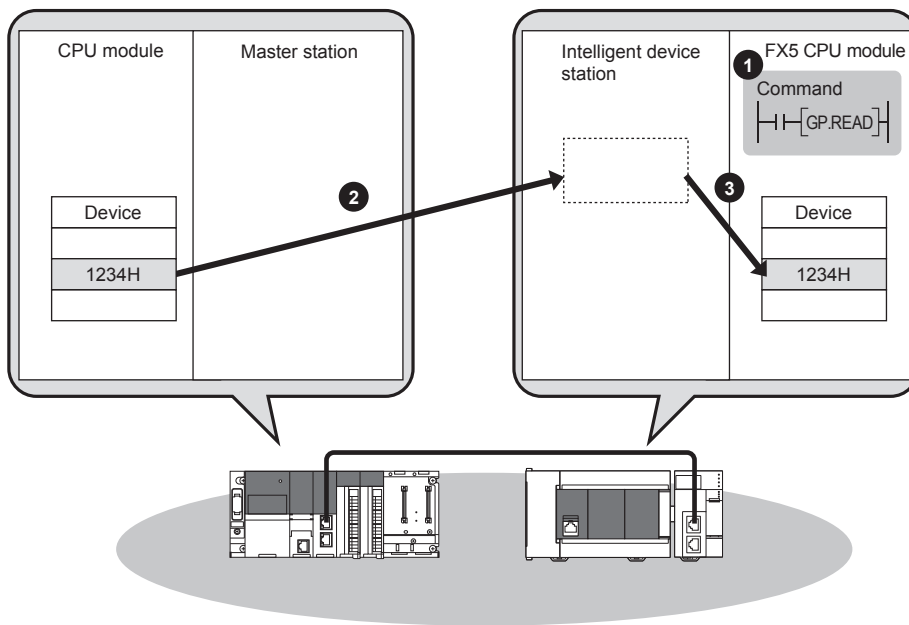

Communications with different networks

This function performs transient transmission seamlessly to stations on different networks using dedicated instructions.

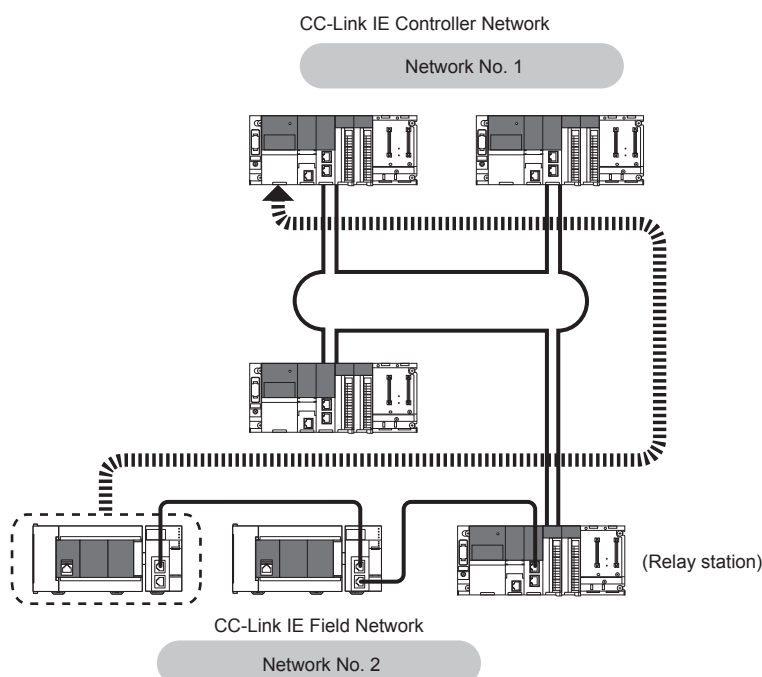

Communications can be made with stations up to eight networks apart (number of relay stations: 7).
 (☞ Page 44 Link dedicated instructions)

When the relay station of own network is a local station, communications can be made with stations up to seven networks apart (number of relay stations: 6).

Setting communication paths allows communication with the following networks.

- Ethernet*¹
- CC-Link IE Controller Network*¹
- MELSECNET/H*¹
- MELSECNET/10*¹

*1 The network cannot be relayed by the FX5.

4.4 Interrupt Request to CPU Module

This function checks interrupt conditions in every link scan and makes an interrupt request to the FX5 CPU module to start the interrupt program if the interrupt conditions are met.

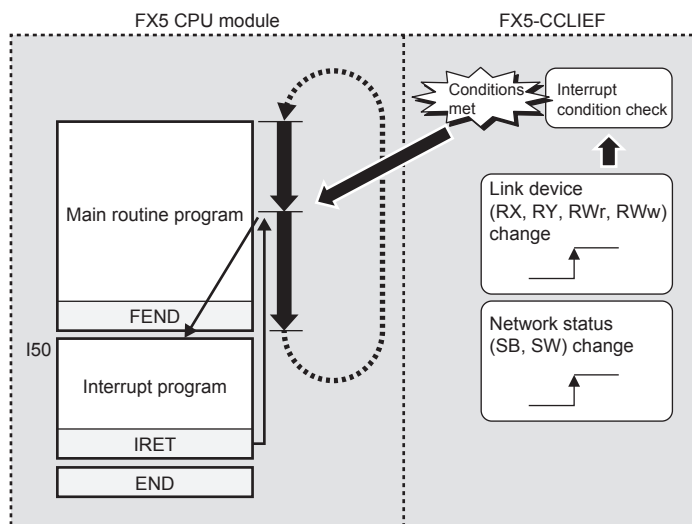

Setting method

Set the interrupt request to the FX5 CPU module in "Interrupt Settings" under "Application Settings". (☞ Page 41 Interrupt Settings)

5 SYSTEM CONFIGURATION

This chapter describes the system configuration of CC-Link IE Field Network.

5.1 CC-Link IE Field Network Configuration

CC-Link IE Field Network is configured using Ethernet cables.

Network topology

Configure the network in star topology, line topology, or ring topology using Ethernet cables.

Star topology and line topology can be combined in a network. Ring topology cannot be combined with star or line topology.

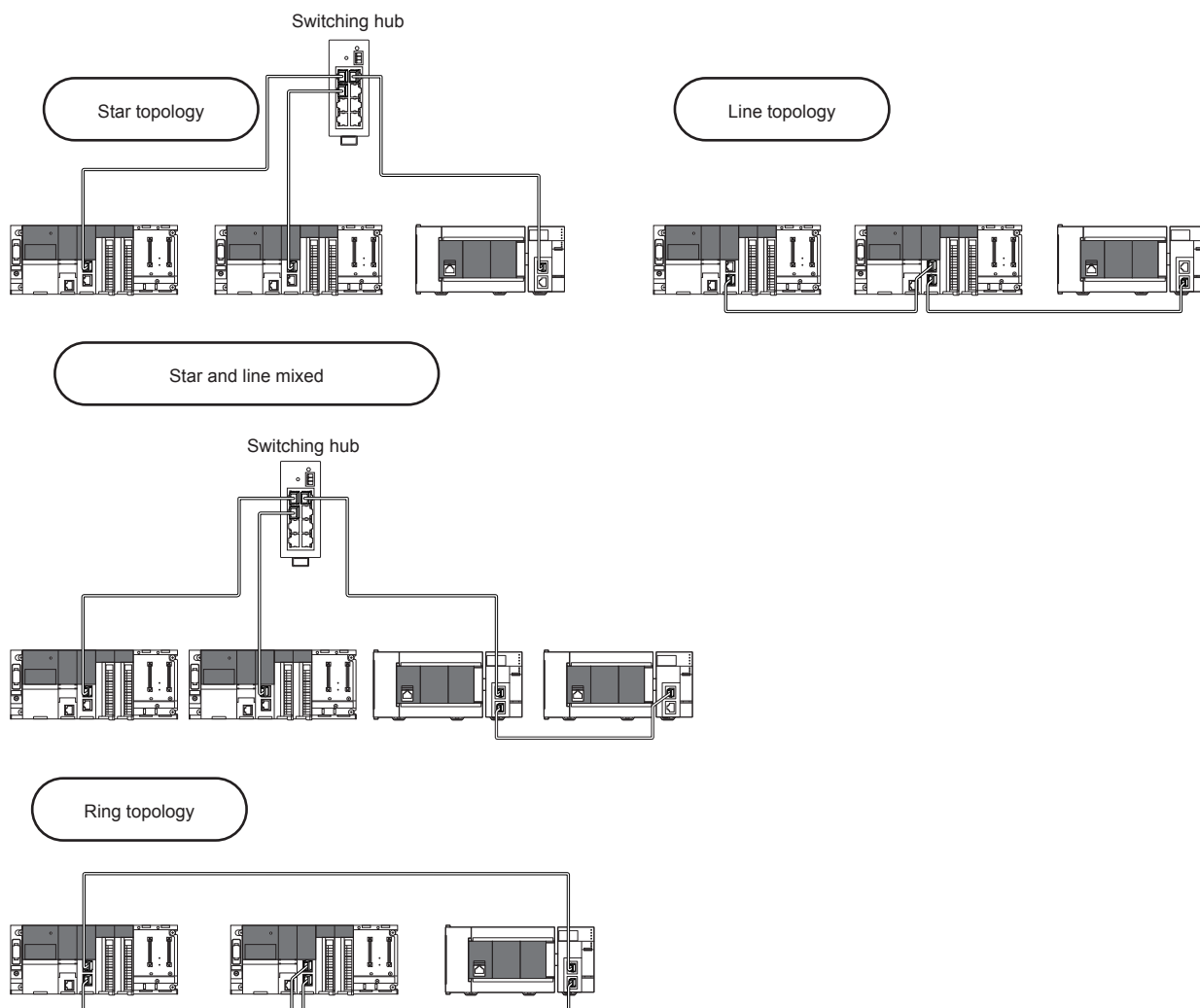

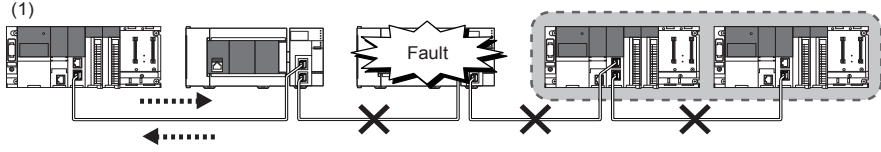
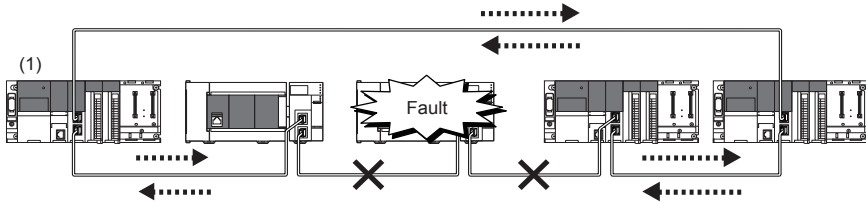
Item	Description
Star topology	The network is configured into a star shape using a switching hub and Ethernet cables. Slave stations can be easily added to the network using this topology. ^{*1} When an error occurs in a slave station, data link can be continued with the stations that are operating normally.
Line topology	The network is configured into a line using Ethernet cables. A switching hub is not required. ^{*1} When an error occurs in a slave station, the stations connected after the faulty station will be disconnected.  (1) Master station (station No. 0)
Ring topology	The network is configured into a ring using Ethernet cables. A switching hub is not required. ^{*1} When an error occurs in a slave station, data link can be continued with the stations that are operating normally.  (1) Master station (station No. 0)

*1 Add/remove slave stations one by one. If multiple slave stations are added/removed at a time, all stations on the network will be reconnected, and an error may momentarily occur in all the stations.

Station number and connection position

Modules can be connected in any order regardless of the station number.

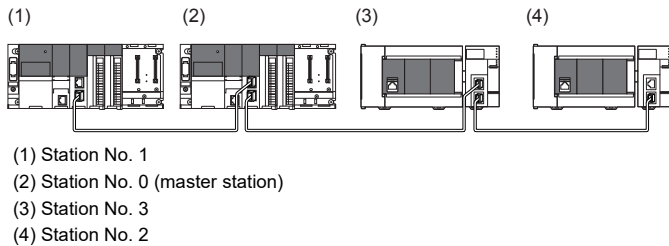

Cascade connection

Cascade connection is available up to 20 stages.

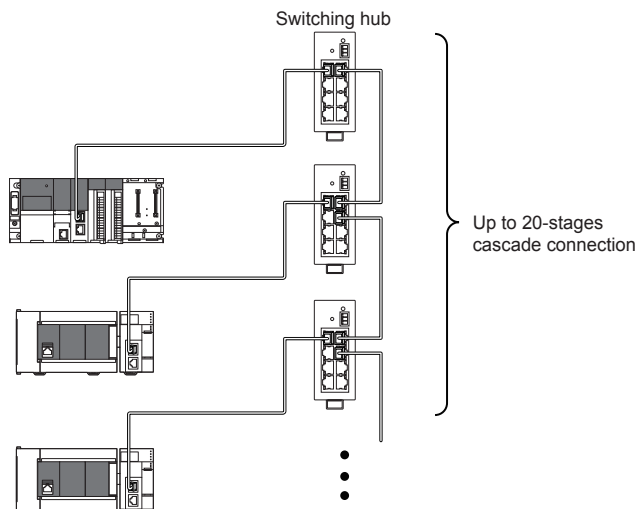

Precautions

■ Addition of slave stations (including submaster station)

Do not connect 121 or more slave stations (including submaster station). If a slave station is added to a system having 120 slave stations (including submaster station), all stations will fail and data link cannot be performed.

■ Configuration in which data link cannot be performed (illegal ring connection)

Do not use a switching hub for ring topology.

■ Ring topology

When using ring topology, set the network topology to "Ring" in the parameter settings for the master station.

For the setting method, refer to the manual for the master station module used.

■ Connecting/disconnecting a cable and powering off/on a device

When the operations listed below are performed, all stations on the network may be reconnected. At this time, a data link error may momentarily occur in all the stations and outputs of the connected slave stations may turn off.

Network configuration	Operation
Star topology	<ul style="list-style-type: none">• Powering off and on a slave station or switching hub• Connecting/disconnecting an Ethernet cable connected to the switching hub• Disconnecting an Ethernet cable from a slave station and connecting it to another slave station or a switching hub• Disconnecting more than 9 stations, or half the number of slave stations or more in the system• Changing the network topology when adding a slave station
Line topology, ring topology	<ul style="list-style-type: none">• Simultaneously powering off/on multiple stations• Simultaneously connecting/disconnecting Ethernet cables to/from multiple stations (When a data link faulty station returns, a data link error will occur in all the stations.)• Disconnecting more than 9 stations, or half the number of slave stations or more in the system• Changing the network topology when adding a slave station

To hold the outputs as a measure when a data link error occurs, set the following to "Hold".

 Navigation window ⇒ [Parameter] ⇒ [Module Information] ⇒ Target module ⇒ [Module Parameter] ⇒ [Application Settings] ⇒ [Supplementary Cyclic Settings] ⇒ [I/O Maintenance Settings] ⇒ [Data Link Error Station Setting]

■ Connected station numbers

Do not duplicate station numbers. Data link may be stopped when the station number is duplicated.

5.2 Precautions for System Configuration

Connecting devices to the same network

For the device connection, observe the following. Failure to do so may cause the disconnection of all stations.

- Do not connect a non CC-Link IE Field Network device in CC-Link IE Field Network. If the device is connected, communications may not be normally performed.
- Do not connect a 100M/10M device or 1 Gbps device which does not support CC-Link IE Field Network to the switching hub (1 Gbps) used in CC-Link IE Field Network. If the device is connected, an error may be detected in the master station and data link may be stopped.

6 WIRING

This chapter describes the wiring methods, wiring products, and wiring precautions when the FX5-CCLIEF is used.

6.1 Power Supply Wiring

Wiring of power connector

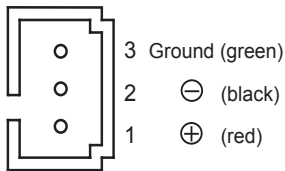

Power supply wiring

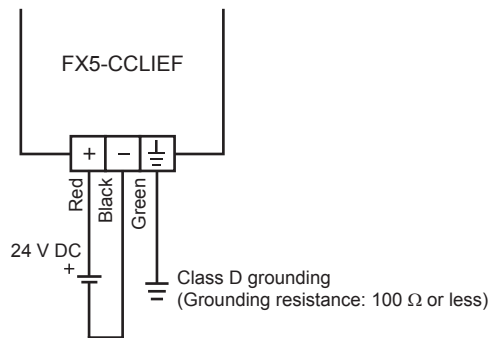

Grounding

Perform the following.

- Perform class D grounding (Grounding resistance: 100 Ω or less).
- Ground the programmable controller independently when possible.
- If the programmable controller cannot be grounded independently, perform the "Shared grounding" shown below.

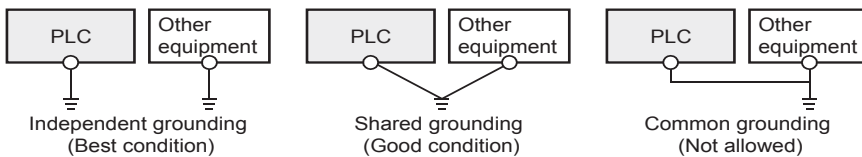

- Bring the grounding point close to the PLC as much as possible so that the ground cable can be shortened.

6.2 Wiring of CC-Link IE Field Network

This section describes the wiring when CC-Link IE Field Network is used.

Wiring methods

The following describes connection and disconnection of the Ethernet cable.

■Connecting the cable

1. Power off the FX5-CCLIEF and external device.
2. Push the Ethernet cable connector into the FX5-CCLIEF until it clicks. Pay attention to the connector's direction.
3. Lightly pull it to check that it is securely connected.
4. Power on the FX5-CCLIEF and external device.
5. Check whether the LINK LED of the port connected with an Ethernet cable is on.*1

*1 The time between the cable connection and the LINK LED turning on may vary. The LINK LED usually turns on in a few seconds. Note, however, that the time may be extended further if the link-up processing is repeated depending on the status of the device on the line. If the LINK LED does not turn on, refer to the following and take corrective actions.

(☞ Page 110 TROUBLESHOOTING)

Point

Both P1 connector and P2 connector can be used.

- When only one connector is used in star topology, either P1 connector or P2 connector is applicable.
- When two connectors are used in line topology and ring topology, the cable can be connected between P1 and P1, P2 and P2, or between P1 and P2.

Connection between P1s or P2s

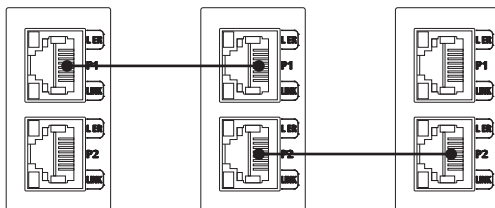

Connection between P1 and P2

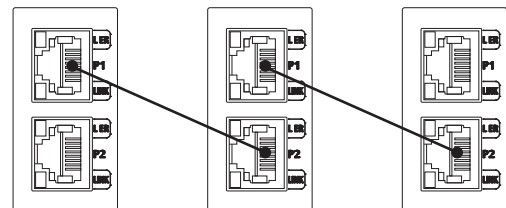

■Disconnecting the cable

1. Power off the FX5-CCLIEF.
2. Press the latch down and unplug the Ethernet cable.

■Precautions

- Place the Ethernet cable in a duct or clamp them. If not, dangling cable may swing or inadvertently be pulled, resulting in damage to the module or cables or malfunction due to poor contact.
- Do not touch the core of the cable-side or module-side connector, and protect it from dirt or dust. If oil from your hand, dirt or dust is attached to the core, it can increase transmission loss, causing a problem in data link.
- Check that the Ethernet cable is not disconnected or not shorted and there is no problem with the connector connection.
- Do not use Ethernet cables with broken latches. Doing so may cause the cable to unplug or malfunction.
- Hold the connector part when connecting and disconnecting the Ethernet cable. Pulling the cable connected to the module may result in malfunction or damage to the module or cable.
- For connectors without Ethernet cable, attached cap should be placed to prevent foreign matter such as dirt or dust.
- The maximum station-to-station distance of the Ethernet cable is 100 m. However, the length may be shorter depending on the operating environment of the cable. For details, contact your cable manufacturer.
- The bend radius of the Ethernet cable is limited. For details, check the specifications of the Ethernet cable to be used.

Wiring products

The following describes the devices used for CC-Link IE Field Network.

■Ethernet cable

Use Ethernet cable that meets the following standards.

Ethernet cable	Connector	Type
Double shielded STP Straight cable	RJ45 connector	• IEEE802.3 (1000BASE-T) • ANSI/TIA/EIA-568-B (Category 5e)

Cables for CC-Link IE Field Network are available from Mitsubishi Electric System & Service Co., Ltd. (Catalogs for cable are also available.)

In addition, the connector processing of your preferred cable length is available. Consult your local Mitsubishi Electric representative.

Type	Model (Manufacturer)
Straight cable (double shielded, STP)	SC-E5EW series (Mitsubishi Electric System & Service Co., Ltd.)

■Hub

Use hubs that meet all the conditions listed below. Operation is not guaranteed if the hubs do not meet these conditions.

- Compliance with the IEEE802.3 (1000BASE-T)
- Support of the auto MDI/MDI-X function
- Support of the auto-negotiation function
- Switching hub (layer 2 switch)^{*1}

*1 A repeater hub is not available.

Type	Model (Manufacturer)
Industrial switching hub	• NZ2EHG-T8N (Mitsubishi Electric Corporation) • NZ2EHG-T8 (Mitsubishi Electric Corporation) (discontinued)

7 PARAMETER SETTINGS

This chapter describes the parameter settings required for communications between the FX5-CCLIEF and other stations.

7.1 Setting Parameters

1. Add the intelligent function module in the engineering tool.
 - Navigation window ⇒ [Parameter] ⇒ [Module Information] ⇒ Right-click ⇒ [Add New Module]
2. The required settings, basic settings, and application settings are included in the parameter settings. Select one of the settings from the tree on the window shown below.
 - [Navigation window] ⇒ [Parameter] ⇒ [Module Information] ⇒ Target module ⇒ [Module Parameter]
3. After setting parameters, click the [Apply] button.
4. Write the settings to the FX5 CPU module using the engineering tool.
 - [Online] ⇒ [Write to PLC]
5. The settings are reflected by resetting the FX5 CPU module or powering off and on the system.

7.2 Required Settings

Set the station type, network number, or other parameters for the FX5-CCLIEF.

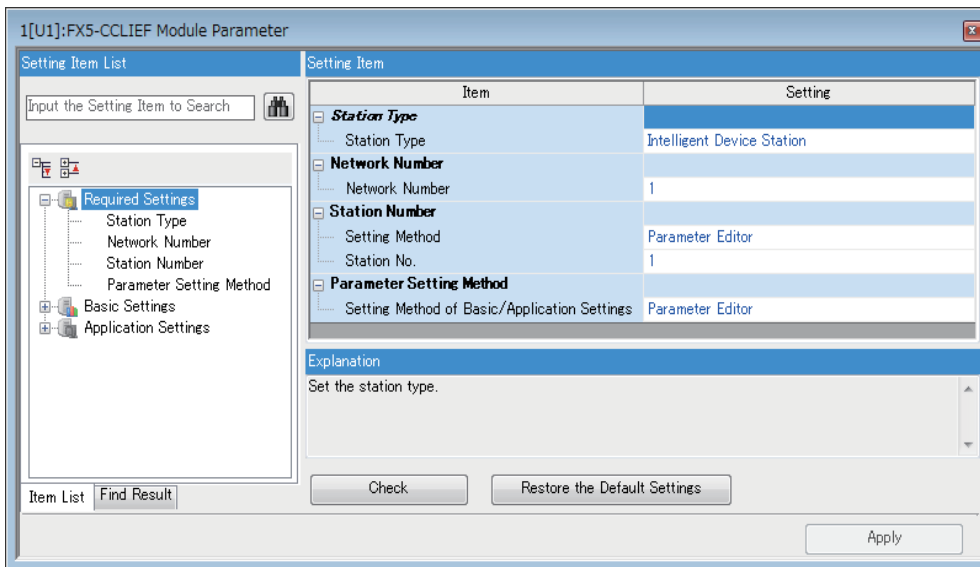

Item	Description	Reference
Station Type	Set the station type. (Fixed to "Intelligent Device Station")	—
Network Number	Set the network number of the FX5-CCLIEF.	Page 37
Station Number	Set the station number setting method and station number of the FX5-CCLIEF.	Page 37
Parameter Setting Method	Select whether to set "Basic Settings" and "Application Settings" items of the FX5-CCLIEF in parameter editor or in program.	Page 37

Point

When the parameters of required settings are not set, the module operates as an intelligent device station of network No. 1 and station No. 1.

Network Number

Set the network number of the FX5-CCLIEF.

Item	Description	Setting range
Network Number	Set the network number of the FX5-CCLIEF.	1 to 239 (Default: 1)

Station Number

Set the station number of the FX5-CCLIEF.

Item	Description	Setting range
Setting Method	Select whether to set the station number in parameter editor or in program (G(P).UINI instruction). When selecting "Program", use the G(P).UINI instruction to set the number. (Page 100 G(P).UINI)	<ul style="list-style-type: none"> Parameter Editor Program (Default: Parameter Editor)
Station No.	Set the station number of the FX5-CCLIEF. Set a station number different from those used in the same network. To set the station number in this setting, set "Setting Method" to "Parameter Editor".	1 to 120 (Default: 1)

Parameter Setting Method

Select whether to set "Basic Settings" and "Application Settings" items of the FX5-CCLIEF in parameter editor or in program.

Item	Description	Setting range
Setting Method of Basic/ Application Settings	<ul style="list-style-type: none"> Parameter Editor Select this item to set the parameter using the engineering tool. The following are advantages. <ul style="list-style-type: none"> Parameters can be easily set in the window without creating a program for setting. Parameters will be automatically transferred to the devices of the FX5 CPU module and the link special relay (SB), link special register (SW), and link devices of the FX5-CCLIEF. Program Select this item to set the parameter using the dedicated instruction (G(P).CCPASET instruction). The following are advantages. <ul style="list-style-type: none"> Parameters can be changed without resetting the FX5 CPU module. 	<ul style="list-style-type: none"> Parameter Editor Program (Default: Parameter Editor)

Station number setting

The station number can be also set using the G(P).UINI instruction. This allows project data items other than the station number to be the same. (Page 100 G(P).UINI)

■When using the engineering tool for the parameter setting

The procedure for setting the station number of the intelligent device station is shown below.

1. Set "Setting Method" under "Station Number" in "Required Settings" to "Program".
2. Set "Setting Method of Basic/Application Settings" under "Parameter Setting Method" in "Required Settings" to "Parameter Editor".
3. Set the station number using the G(P).UINI instruction.

■When using the G(P).CCPASET instruction for the parameter setting

The procedure for setting the station number of the intelligent device station is shown below.

1. Set "Station Type" under "Station Type" in "Required Settings" and "Network Number" under "Network Number" in "Required Settings".
2. Set "Setting Method" under "Station Number" in "Required Settings" to "Program".
3. Set "Setting Method of Basic/Application Settings" under "Parameter Setting Method" in "Required Settings" to "Program".
4. Set the network parameters using the G(P).CCPASET instruction.
5. Set the station number using the G(P).UINI instruction.

7.3 Basic Settings

Set the refresh settings of the FX5-CCLIEF.

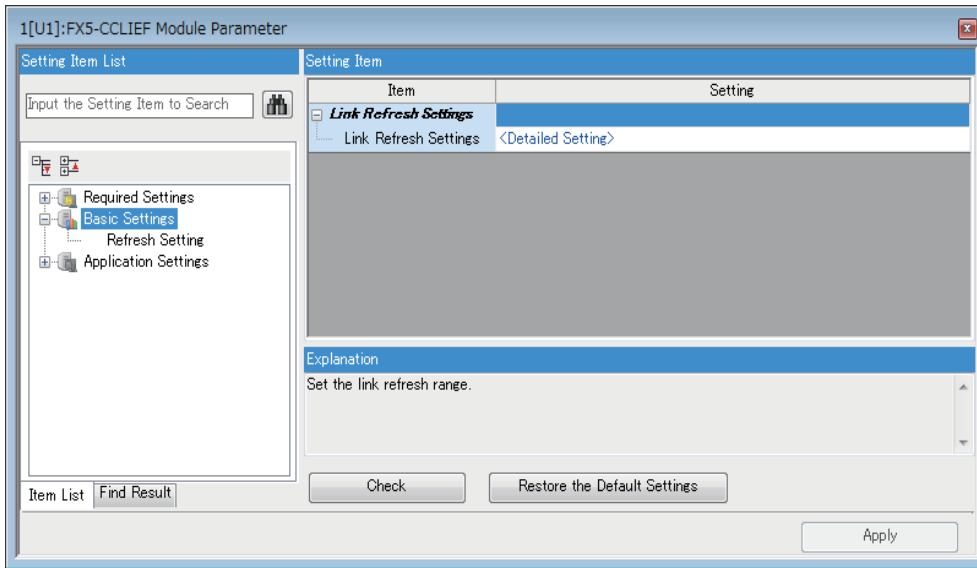

Item	Description	Reference
Refresh Setting	Set link refresh ranges between the devices of the FX5 CPU module and the link special relay (SB), link special register (SW), and link devices of the FX5-CCLIEF.	Page 38

Refresh setting

Set link refresh ranges between the devices of the FX5 CPU module and link devices of the FX5-CCLIEF.

Setting method

The procedure for the refresh settings is shown below.

1. Set the required items.
2. Click the [Apply] button and close "Refresh Setting".

Setting items

The setting items for refresh settings are as follows:

No.	Link Side					CPU Side				
	Device Name	Points	Start	End		Target	Device Name	Points	Start	End
-	SB	512	00000	001FF	↔	Device	SB	512	00000	001FF
-	SW	512	00000	001FF	↔	Device	SW	512	00000	001FF
1					↔					
2					↔					
3					↔					
4					↔					
5					↔					

Item	Description	Setting range
Device Assignment Method	Right-click in the "Refresh Setting" window and select a link device assignment method. <ul style="list-style-type: none"> • Start/End: Enter the start and end numbers of link devices. • Points/Start: Enter the points and start numbers of link devices. 	<ul style="list-style-type: none"> • Start/End • Points/Start (Default: Start/End)

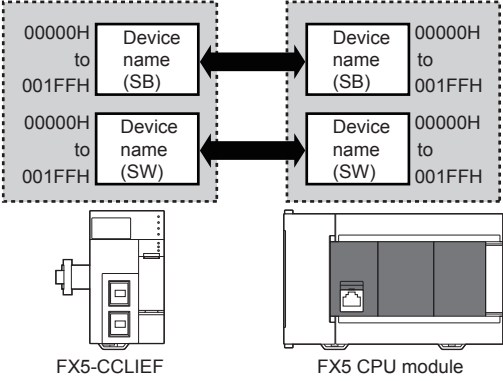
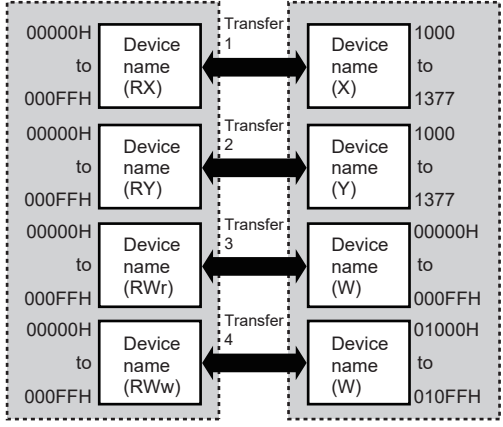
Item	Description	Setting range																																																																																
<p>—</p> <p>Link Side</p> <p>CPU Side</p>	<p>Set the link refresh ranges of SB and SW. One range can be set for each of SB and SW. (☞ Page 21 Link refresh)</p> <p>Ex.</p> <table border="1" data-bbox="336 293 957 376"> <thead> <tr> <th colspan="5">Link Side</th> <th colspan="5">CPU Side</th> </tr> <tr> <th>No.</th> <th>Device Name</th> <th>Points</th> <th>Start</th> <th>End</th> <th>Target</th> <th>Device Name</th> <th>Points</th> <th>Start</th> <th>End</th> </tr> </thead> <tbody> <tr> <td>—</td> <td>SB</td> <td>512</td> <td>00000</td> <td>001FF</td> <td>Device</td> <td>SB</td> <td>512</td> <td>00000</td> <td>001FF</td> </tr> <tr> <td>—</td> <td>SW</td> <td>512</td> <td>00000</td> <td>001FF</td> <td>Device</td> <td>SW</td> <td>512</td> <td>00000</td> <td>001FF</td> </tr> </tbody> </table>  <p>FX5-CCLIEF</p> <p>FX5 CPU module</p>	Link Side					CPU Side					No.	Device Name	Points	Start	End	Target	Device Name	Points	Start	End	—	SB	512	00000	001FF	Device	SB	512	00000	001FF	—	SW	512	00000	001FF	Device	SW	512	00000	001FF	<p>Device Name</p> <ul style="list-style-type: none"> • SB (fixed) • SW (fixed) <p>Points</p> <ul style="list-style-type: none"> • SB: 16 to 512 • SW: 1 to 512 <p>(Default: 512)</p> <p>Start</p> <ul style="list-style-type: none"> • SB: 0H to 1F0H (set in increments of 16 points) • SW: 0H to 1FFH (set in increments of 1 point) <p>(Default: 0H)</p> <p>End</p> <ul style="list-style-type: none"> • SB: FH to 1FFH (set in increments of 16 points) • SW: 0H to 1FFH (set in increments of 1 point) <p>(Default: 1FFH)</p> <p>Target</p> <ul style="list-style-type: none"> • Device <p>(Default: Device)</p> <p>Device Name</p> <ul style="list-style-type: none"> • Device (when link side is SB): SB, M, L, B, D, R • Device (when link side is SW): SW, M, L, B, D, R <p>Points, Start, End</p> <ul style="list-style-type: none"> • Range of the device in the FX5 CPU module • Set bit devices in increments of 16 points and word devices in increments of 1 points. 																																								
Link Side					CPU Side																																																																													
No.	Device Name	Points	Start	End	Target	Device Name	Points	Start	End																																																																									
—	SB	512	00000	001FF	Device	SB	512	00000	001FF																																																																									
—	SW	512	00000	001FF	Device	SW	512	00000	001FF																																																																									
<p>1 to 256</p> <p>Link Side</p> <p>CPU Side</p>	<p>Set the link refresh ranges of RX, RY, RWr, and RWw. Up to 256 ranges can be set. (☞ Page 21 Link refresh)</p> <p>Ex.</p> <table border="1" data-bbox="336 972 957 1122"> <thead> <tr> <th colspan="5">Link Side</th> <th colspan="5">CPU Side</th> </tr> <tr> <th>No.</th> <th>Device Name</th> <th>Points</th> <th>Start</th> <th>End</th> <th>Target</th> <th>Device Name</th> <th>Points</th> <th>Start</th> <th>End</th> </tr> </thead> <tbody> <tr> <td>—</td> <td>SB</td> <td>512</td> <td>00000</td> <td>001FF</td> <td>Specify Devi</td> <td>SB</td> <td>512</td> <td>00000</td> <td>001FF</td> </tr> <tr> <td>—</td> <td>SW</td> <td>512</td> <td>00000</td> <td>001FF</td> <td>Specify Devi</td> <td>SW</td> <td>512</td> <td>00000</td> <td>001FF</td> </tr> <tr> <td>1</td> <td>RX</td> <td>256</td> <td>00000</td> <td>000FF</td> <td>Specify Devi</td> <td>X</td> <td>256</td> <td>1000</td> <td>1377</td> </tr> <tr> <td>2</td> <td>RY</td> <td>256</td> <td>00000</td> <td>000FF</td> <td>Specify Devi</td> <td>Y</td> <td>256</td> <td>1000</td> <td>1377</td> </tr> <tr> <td>3</td> <td>RW</td> <td>256</td> <td>00000</td> <td>000FF</td> <td>Specify Devi</td> <td>W</td> <td>256</td> <td>00000</td> <td>000FF</td> </tr> <tr> <td>4</td> <td>RWw</td> <td>256</td> <td>00000</td> <td>000FF</td> <td>Specify Devi</td> <td>W</td> <td>256</td> <td>01000</td> <td>010FF</td> </tr> </tbody> </table>  <p>FX5-CCLIEF</p> <p>FX5 CPU module</p>	Link Side					CPU Side					No.	Device Name	Points	Start	End	Target	Device Name	Points	Start	End	—	SB	512	00000	001FF	Specify Devi	SB	512	00000	001FF	—	SW	512	00000	001FF	Specify Devi	SW	512	00000	001FF	1	RX	256	00000	000FF	Specify Devi	X	256	1000	1377	2	RY	256	00000	000FF	Specify Devi	Y	256	1000	1377	3	RW	256	00000	000FF	Specify Devi	W	256	00000	000FF	4	RWw	256	00000	000FF	Specify Devi	W	256	01000	010FF	<p>Device Name</p> <ul style="list-style-type: none"> • RX, RY, RWr, RWw <p>(Default: Blank)</p> <p>Points</p> <ul style="list-style-type: none"> • RX, RY: 16 to 384 • RWr, RWw: 4 to 1024 <p>(Default: Blank)</p> <p>Start</p> <ul style="list-style-type: none"> • RX, RY: 0H to 170H (set in increments of 16 points) • RWr, RWw: 0 to 3FCH (set in increments of 4 points) <p>(Default: Blank)</p> <p>End</p> <ul style="list-style-type: none"> • RX, RY: FH to 17FH (set in increments of 16 points) • RWr, RWw: 3H to 3FFH (set in increments of 4 points) <p>(Default: Blank)</p> <p>Target</p> <ul style="list-style-type: none"> • Device <p>(Default: Blank)</p> <p>Device Name</p> <ul style="list-style-type: none"> • Device (when link side is RX): X, M, L, B, D, W, R • Device (when link side is RY): Y, M, L, B, D, W, R • Device (when link side is RWr): M, L, B, D, W, R • Device (when link side is RWw): M, L, B, D, W, R <p>(Default: Blank)</p> <p>Points, Start, End</p> <ul style="list-style-type: none"> • Range of the device in the FX5 CPU module • Set bit devices in increments of 16 points and word devices in increments of 4 points. <p>(Default: Blank)</p>
Link Side					CPU Side																																																																													
No.	Device Name	Points	Start	End	Target	Device Name	Points	Start	End																																																																									
—	SB	512	00000	001FF	Specify Devi	SB	512	00000	001FF																																																																									
—	SW	512	00000	001FF	Specify Devi	SW	512	00000	001FF																																																																									
1	RX	256	00000	000FF	Specify Devi	X	256	1000	1377																																																																									
2	RY	256	00000	000FF	Specify Devi	Y	256	1000	1377																																																																									
3	RW	256	00000	000FF	Specify Devi	W	256	00000	000FF																																																																									
4	RWw	256	00000	000FF	Specify Devi	W	256	01000	010FF																																																																									

Precautions

■Device set to "CPU Side"

Set a device range not to overlap with the one used for the following:

- "Refresh Setting" of intelligent function modules

■Link refresh range

Set only link devices used in the FX5 CPU module for link refresh range. Doing so will reduce link refresh points, resulting in a shorter link refresh time.

7.4 Application Settings

Set the supplementary cyclic settings, interrupt settings, or other parameters for the FX5-CCLIEF.

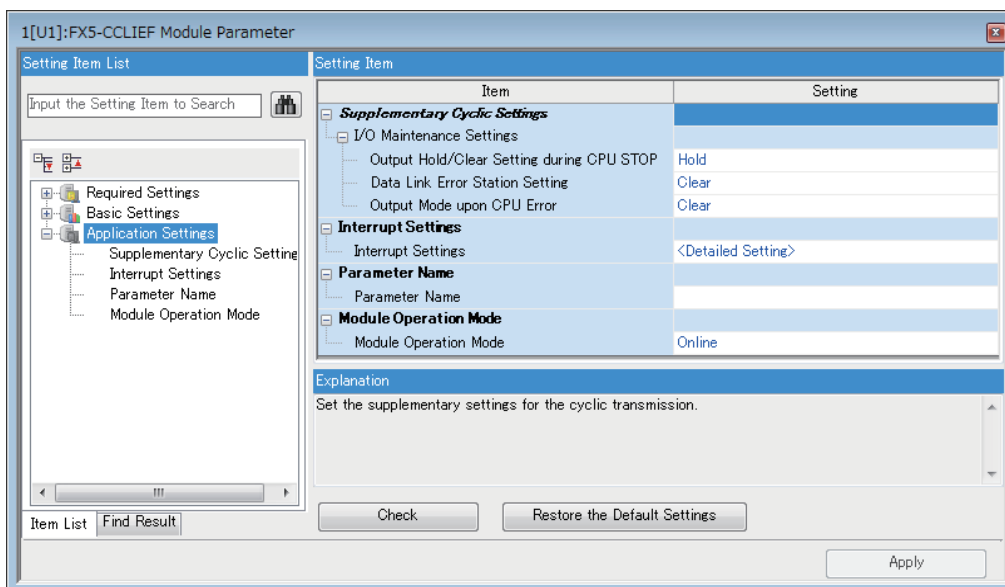

Item	Description	Reference
Supplementary Cyclic Settings	Set the I/O maintenance settings.	Page 40
Interrupt Settings	Set conditions for sending an interrupt request to the FX5 CPU module.	Page 41
Parameter Name	Set a name for the module parameter if desired.	Page 43
Module Operation Mode	Set the mode of the FX5-CCLIEF.	Page 43

Supplementary Cyclic Settings

Set the I/O maintenance settings.

Item	Description	Setting range
I/O Maintenance Settings	Output Hold/Clear Setting during CPU STOP	Select whether cyclic data output is held or cleared when the FX5 CPU module connected to the FX5-CCLIEF is set to STOP state. (Page 27 Output status setting for CPU STOP)
	Data Link Error Station Setting	Select whether input data from the master station when a data link error occurs is cleared or held. (Page 26 Input and output status settings when failure occurs)
	Output Mode upon CPU Error	When a stop error occurs in the FX5 CPU module connected to the FX5-CCLIEF, whether cyclic transmission output data is held or cleared can be selected. (Page 26 Input and output status settings when failure occurs)
		<ul style="list-style-type: none"> • Hold • Clear (Default: Hold)
		<ul style="list-style-type: none"> • Clear • Hold (Default: Clear)
		<ul style="list-style-type: none"> • Clear • Hold (Default: Clear)

Interrupt Settings

Set conditions for sending an interrupt request to the FX5 CPU module.

Setting method

The procedure for the interrupt settings is shown below.

1. Set the interrupt conditions.

Up to 16 interrupt conditions can be set.

No.	Device Code	Device No.	Detection Method	Condition Type	Condition Value	Interrupt Pointer	Comment
SI 00							
SI 01							
SI 02							
SI 03							
SI 04							
SI 05							
SI 06							
SI 07							
SI 08							
SI 09							
SI 10							
SI 11							
SI 12							

2. Click the [Apply] button and close "Interrupt Settings".

Setting items

Item	Description	Setting range
Word Device Setting Value Input Format	Right click in the "Interrupt Settings" window and select from "Word Device Setting Value Input Format".	<ul style="list-style-type: none"> Decimal Hexadecimal (Default: Decimal)
Device Code	Set an interrupt condition device.	Refer to the following table.
Device No.		
Detection Method	Select the detection timing of an interrupt generated by the device set in "Device" and "Device No.".	
Condition Type		
Condition Value	When "RWw", "RWr", or "SW" is selected in "Device", enter a word device value that triggers an interrupt.	
Interrupt Pointer	Set an interrupt pointer (I) to be used for an interrupt program.	
Comment	Set a comment for the interrupt pointer used.	—

(Setting range)

Device	Device No.	Detection Method	Condition Type	Condition Value	Interrupt Pointer
RX	0H to 17FH	Level + ON: Interrupt occurs by turning on the device. Level + OFF: Interrupt occurs by turning off the device. Edge + ON: Interrupt occurs at the rising edge of the device. Edge + OFF: Interrupt occurs at the falling edge of the device.		—	Device: I50 to I177
RY	0H to 17FH				
SB	0H to 1FFH				
RWr	0H to 3FFH	Level + Values Match: Interrupt occurs when values match. Level + Values Mismatch: Interrupt occurs when values do not match. Edge + Values Match: Interrupt occurs when values match (first time only). Edge + Values Mismatch: Interrupt occurs when values do not match (first time only).		0 to 65535 (0H to FFFFH)	
RWw	0H to 3FFH				
SW	0H to 1FFH				

Point

Using an interrupt program will eliminate the need for describing a start condition in a program. This leads to reduction in the number of steps and sequence scan time.

Precautions

■When "Detection Method" is set to "Level" and the interrupt condition is always met

If the sequence scan takes much longer than the link scan, since interrupt processing is activated in each link scan, sequence scan time may greatly increase, resulting in a watchdog timer error of the FX5 CPU module.

When "Detection Method" is set to "Level" and the interrupt condition is always met, do not use interrupt settings and correct the interrupt condition in the program.

■When multiple interrupts have simultaneously occurred

The operation may be delayed.

■When the mode of the FX5-CCLIEF is "Module Communication Test" or "Offline"

The master/local module can send an interrupt request to the FX5 CPU module when the mode is "Online". The module cannot send the request when the mode is "Module Communication Test" and "Offline".

■An interrupt cannot be generated

Changes in the interrupt condition device cannot be detected if the change is shorter than the transmission delay time.

■When the link refresh setting is performed

Even if the link refresh setting is performed, the buffer memory needs to be referred in the interrupt program because link refresh is not performed to FX5 CPU module devices at the execution timing of an interrupt program.

Setting examples

■Starting the interrupt program of the slave station (station No. 1) when RY100 turns on

Ex.

The following is a setting example to execute the interrupt program corresponding to the interrupt pointer I50 when RY100 turns on by turning on the corresponding switch on the master station side.

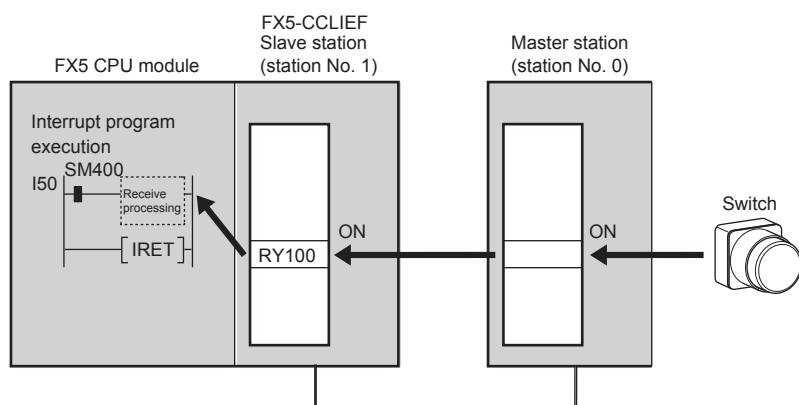

Set the interrupt setting parameters for the FX5-CCLIEF (station No. 1) in "Interrupt Settings" as shown below.

No.	Device Code	Device No.	Detection Method	Condition Type	Condition Value	Interrupt Pointer	Comment
SI 00	RY	00100	Edge	ON		I50	
SI 01							
SI 02							

Point

By using link special relay (SB) and link special register (SW) as an interrupt condition device, an interrupt program can be started in case of data link error. (Page 135 List of Link Special Relay (SB), Page 139 List of Link Special Register (SW))

Parameter Name

Set a name for the module parameter if desired.

Item	Description	Setting range
Parameter Name	Set a name for the module parameter if desired.	Up to 8 one-byte or two-byte characters (Default: Blank)

Module Operation Mode

Set the mode of the FX5-CCLIEF.

For details on module communication test mode, refer to the following.

( Page 113 Module communication test)

Item	Description	Setting range
Module Operation Mode	<p>Online</p> <ul style="list-style-type: none">• Select this mode to connect the FX5-CCLIEF to the network for performing data link with other stations. <p>Offline</p> <ul style="list-style-type: none">• Select this mode to disconnect the FX5-CCLIEF from the network for stopping data link with other stations. <p>Module Communication Test</p> <ul style="list-style-type: none">• Select this mode to check the hardware of the FX5-CCLIEF. Select this mode to check the module hardware when communication is unstable.	<ul style="list-style-type: none">• Online• Offline• Module Communication Test (Default: Online)

Restriction

The following functions are disabled when "Module Operation Mode" is set to "Offline" or "Module Communication Test". ( Page 18 FUNCTIONS)

- Cyclic transmission
- Transient transmission
- RAS (Automatic return)
- Interrupt request to CPU module

8 DEDICATED INSTRUCTION

This chapter describes dedicated instructions that can be used in the FX5-CCLIEF.

Link dedicated instructions

The following table lists the instructions used for transient transmission to or from programmable controllers on other stations. Each link dedicated instruction allows access to a station on a network other than CC-Link IE Field Network.

■Instruction list

Instruction	Description	Reference
GP.READ	Reads data from a device in another station programmable controller.	Page 47 GP.READ
GP.SREAD	Reads data from a device in another station programmable controller. After the data reading is completed by the GP.SREAD instruction, a device of the other station is turned on. The other station can recognize that data has been read by the GP.SREAD instruction.	Page 55 GP.SREAD
GP.WRITE	Writes data to a device in another station programmable controller.	Page 61 GP.WRITE
GP.SWRITE	Writes data to a device in another station programmable controller. After the data writing is completed by the GP.SWRITE instruction, a device of the other station is turned on. The other station can recognize that data has been written by the GP.SWRITE instruction.	Page 70 GP.SWRITE
GP.SEND	Sends data to another station programmable controller.	Page 77 GP.SEND
GP.RECV	Reads data received from another station programmable controller.	Page 88 GP.RECV

■Transient transmission range

In a single network system, communication with all stations on the network is possible.

In multi-network system, communications can be made with stations up to eight networks apart.

■Target networks and target station types

Each link dedicated instruction allows access to a station on a network other than the own station network.

The following table lists the target stations of each instruction.

Instruction symbol	Target station (another station)	
	Target network	Target station type
GP.READ GP.SREAD	<ul style="list-style-type: none"> • Ethernet • CC-Link IE Controller Network • CC-Link IE Field Network • MELSECNET/H • MELSECNET/10 	<ul style="list-style-type: none"> • QCPU • LCPU • QSCPU • QnACPU • FX5CPU • Intelligent device station
GP.WRITE GP.SWRITE	<ul style="list-style-type: none"> • Ethernet • CC-Link IE Controller Network • CC-Link IE Field Network • MELSECNET/H • MELSECNET/10 	<ul style="list-style-type: none"> • QCPU • LCPU • QnACPU • FX5CPU • Intelligent device station
GP.SEND GP.RECV	<ul style="list-style-type: none"> • Ethernet • CC-Link IE Controller Network • CC-Link IE Field Network • MELSECNET/H • MELSECNET/10 	<ul style="list-style-type: none"> • QCPU • LCPU • QnACPU • FX5CPU • Interface board for personal computer*¹

*1 These instructions can access the following personal computer interface boards having the SEND/RECV functions. CC-Link IE Field Network interface board, CC-Link IE Controller Network interface board, MELSECNET/H interface board, and MELSECNET/10 interface board

■ Specifications of character string data specified by link dedicated instructions

Some operands specified in link dedicated instructions are specified in character strings. The following table summarizes the specifications of character string data specified.

Instruction symbol	Applicable operand	Specifications of character string data
GP.READ	(s2)	<ul style="list-style-type: none"> ■ Specification method
GP.SREAD	(s2)	Specify a character string by enclosing it in single quotes (').
GP.WRITE	(d1)	<ul style="list-style-type: none"> ■ Specifiable device types • Word device: D, W, SW, SD, T, C, ST, ZR, R • Nibble-specified bit device: X, Y, M, L, B, F, SB, SM
GP.SWRITE	(d1)	<ul style="list-style-type: none"> ■ ASCII string specifications • An ASCII string can consist of a maximum of 32 characters. (Specify NULL as the termination character.) • ASCII strings are zero-suppressed. (Example: D1 and D001 are handled the same.) • ASCII strings are case-sensitive. ■ Precautions Nibble-specified bit devices can be specified only when the following conditions are all satisfied. <ul style="list-style-type: none"> • The device number is a multiple of 16 (10H). • The number of specified nibbles is 4 (K4). An instruction specifying bit devices by nibble can be executed only when the target station is FX5CPU, RCP, basic model QCPU, universal model QCPU, or LCP. If an instruction uses nibble specification for other types of CPU modules, an abnormal response is returned from the target station and the instruction is completed with an error. (The network module does not detect an error during execution of the instruction.) The target device of an instruction executed in index modification mode is determined by the value of the index register of the own station. When specifying X and Y devices, specify the device number in hexadecimal.
GP.SREAD	(d3)	<ul style="list-style-type: none"> ■ Specification method
GP.SWRITE	(d3)	Specify a character string by enclosing it in single quotes (').
		<ul style="list-style-type: none"> ■ Specifiable device types • Bit specification of word device: D, W, SW, SD, ZR, R • Bit device: X, Y, M, L, B, F, SB, SM • Bit device index modification: Z ■ ASCII string specifications • An ASCII string can consist of a maximum of 32 characters. (Specify NULL as the termination character.) • ASCII strings are zero-suppressed. (Example: D1 and D001 are handled the same.) • ASCII strings are case-sensitive. ■ Precautions The target device of an instruction executed in index modification mode is determined by the value of the index register of the own station. When specifying X and Y devices, specify the device number in hexadecimal.

Other dedicated instructions

Set the parameters to the intelligent device station (own station).

■ Instruction list

Instruction	Description	Reference
G(P).CCPASET	Set the parameters to the FX5-CCLIEF.	Page 94 G(P).CCPASET
G(P).UINI	Set the station number to the FX5-CCLIEF.	Page 100 G(P).UINI

8.1 Precautions for Dedicated Instructions

This section describes precautions when using dedicated instructions.

Precautions for dedicated instructions (common)

■When changing data specified by dedicated instructions

Do not change any data (such as control data) until execution of the dedicated instruction is completed.

■When the dedicated instruction is not completed

Check whether the mode of the FX5-CCLIEF is online.

A dedicated instruction cannot be executed when the mode is offline or module communication test.

Precautions for link dedicated instructions

The following describes precautions when executing multiple link dedicated instructions simultaneously.

■Channel of the link dedicated instructions

When executing multiple link dedicated instructions simultaneously, check that the channels for the instructions are not duplicated. Multiple link dedicated instructions specifying the same channel cannot be used concurrently. To use the same channel for multiple link dedicated instructions, configure an interlock so that one instruction is executed after completion of another.

■If the link dedicated instruction is simultaneously executed

If executed, the instruction that is requested later is skipped. If skipped, the dedicated instruction skip flag (SM699) turns on.

8.2 Link Dedicated Instructions

Reading data from the programmable controller on another station

GP.READ

This instruction reads data from a device in another station programmable controller. (In units of words)

Ladder	ST
	<pre>ENO:=GP_READ(EN,Un,s1,s2,d1,d2);</pre>

FBD/LD

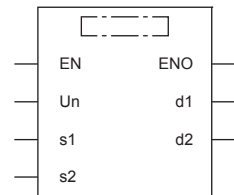

("GP_READ" enters □.)

Setting data

■Description, range, data type

Operand	Description	Range	Data type	Data type (label)
(U) ^{*1}	Position number of the module connected	<ul style="list-style-type: none"> ■FX5UJ CPU module 1H to 8H ■FX5U/FX5UC CPU module 1H to 10H 	16-bit unsigned binary	ANY16
(s1)	Own station head device where control data is stored	Refer to Page 48 Control data.	Device name	ANY16 ^{*4}
(s2)	Target station head device where the data to be read is stored	—	Character string ^{*2}	ANYSTRING_SINGLE ^{*2}
(d1)	Own station head device for storing the read data ^{*3}	—	Device name	ANY16 ^{*4}
(d2)	Own station device to be turned on for one scan when the instruction completes. (d2)+1 also turns on when the instruction completes with an error.	—	Bit	ANYBIT_ARRAY (Number of elements: 2)
EN	Execution condition	—	Bit	BOOL
ENO	Execution result	—	Bit	BOOL

*1 In the case of the ST language and the FBD/LD language, U displays as Un.

*2 For the specifications of the string data to be specified, refer to the following.
(Page 45 Specifications of character string data specified by link dedicated instructions)

*3 The continuous area specified by the read data length (s1)+9 is required.

*4 Digit specified bit type label cannot be used.

■Applicable devices

Operand	Bit	Word			Double word		Indirect specification	Constant			Others (U)
	X, Y, M, L, SM, F, B, SB, S	T, ST, C, D, W, SD, SW, R	U□\G□	Z	LC	LZ		K, H	E	\$	
(U)	—	○	—	—	—	—	○	○	—	—	○
(s1)	—	○	—	—	—	—	○	—	—	—	—
(s2)	—	—	—	—	—	—	—	—	—	○	—
(d1)	—	○	—	—	—	—	○	—	—	—	—
(d2)	○*1	○*2	—	—	—	—	—	—	—	—	—

*1 S cannot be used.

*2 T, ST, and C cannot be used.

■Control data

Device	Item	Description	Setting range	Set by			
(s1)+0	Error completion type	b15 ... b8 b7 b6 ... b0 <table border="1" style="margin-left: 40px;"> <tr> <td style="width: 40px;">0</td> <td style="width: 40px;">(1)</td> <td style="width: 40px;">0</td> </tr> </table> (1) Error completion type (bit 7) Specify whether to set data at completion with an error. • 0: Do not set data in (s1)+11 and later at completion with an error. • 1: Set data in (s1)+11 and later at completion with an error.	0	(1)	0	0000H 0080H	User
0	(1)	0					
(s1)+1	Completion status	The instruction completion status is stored. • 0: Normal • Other than 0: Error (error code)	—	System			
(s1)+2	Own station channel	Specify the channel to be used by own station.	1, 2	User			
(s1)+3	Target station CPU type	Specify the CPU type of the target station. • 0000H: Addressed to target station CPU (control CPU) • 03D0H: Addressed to control system CPU • 03D1H: Addressed to standby system CPU • 03D2H: Addressed to system A CPU • 03D3H: Addressed to system B CPU • 03E0H: Addressed to multiple CPU No. 1 • 03E1H: Addressed to multiple CPU No. 2 • 03E2H: Addressed to multiple CPU No. 3 • 03E3H: Addressed to multiple CPU No. 4 • 03FFH: Addressed to target station CPU (control CPU)	0000H 03D0H to 03D3H 03E0H to 03E3H 03FFH	User			
(s1)+4	Target network number	Specify the network number (1 to 239) of the target station.	1 to 239	User			
(s1)+5	Target station number	Specify the station number of the target station. • 125: Master station • 126: Master operating station • 1 to 120: Local station, intelligent device station, submaster station	1 to 120, 125, 126	User			
(s1)+6	Not used	—	—	—			
(s1)+7	Number of resends	■Before instruction execution Specify the number of resends to be performed if the instruction is not completed within the monitoring time specified by (s1)+8. ■At completion of instruction The number of resends performed (result) is stored.	0 to 15	User/ system			
(s1)+8	Arrival monitoring time	Specify the monitoring time until completion of processing. If processing is not completed within the monitoring time, the request is resent by the number of resends specified in (s1)+7. • 0: 10 seconds • 1 to 32767: 1 to 32767 seconds	0 to 32767	User			
(s1)+9	Read data length	Specify the number of words to be read. • 1 to 960 (words) (When reading data from QnACPU: 1 to 480 (words))	1 to 960	User			
(s1)+10	Not used	—	—	—			
(s1)+11	Clock setting flag	The validity status (valid or invalid) of the data in (s1)+12 and later is stored. Note that the data in (s1)+12 and later is not cleared even when the instruction is completed successfully. • 0: Invalid • 1: Valid	—	System			

Device	Item	Description	Setting range	Set by
(s1)+12	Clock data (Set only in an abnormal state)	Upper 8 bits: Month (01H to 12H) Lower 8 bits: Lower 2 digits of year (00H to 99H)	—	System
(s1)+13		Upper 8 bits: Hour (00H to 23H) Lower 8 bits: Day (01H to 31H)	—	System
(s1)+14		Upper 8 bits: Second (00H to 59H) Lower 8 bits: Minute (00H to 59H)	—	System
(s1)+15		Upper 8 bits: Upper 2 digits of the year (00H to 99H) Lower 8 bits: Day of the week (00H (Sun.) to 06H (Sat.))	—	System
(s1)+16	Error detection network number* ¹	The network number of the station in which an error was detected is stored. (No information is stored if an error is detected in the own station.) • 1 to 239 (Network number)	—	System
(s1)+17	Error-detected station number* ¹	The station number of the station where an error was detected is stored. (No information is stored if an error is detected in the own station.) • 125: Master station • 1 to 120: Local station, intelligent device station, submaster station	—	System

*¹ If completion status ((s1)+1) is "Channel in use (dedicated instruction) (error codes: D25AH and D25BH)", data is not stored.

Point

The number of resends (s1)+7 must be set every time the instruction is executed.

Processing details

- The instruction reads data by the specified number of words ((s1)+9) from the target station head device (s2) into the own station head device (after (d1)). Specify the target stations in control data ((s1)+4) and ((s1)+5). Upon completion of reading the device data specified by (s2), the completion device specified by (d2) turns on.
- For the target stations that can be specified, refer to the following.

Page 44 Target networks and target station types

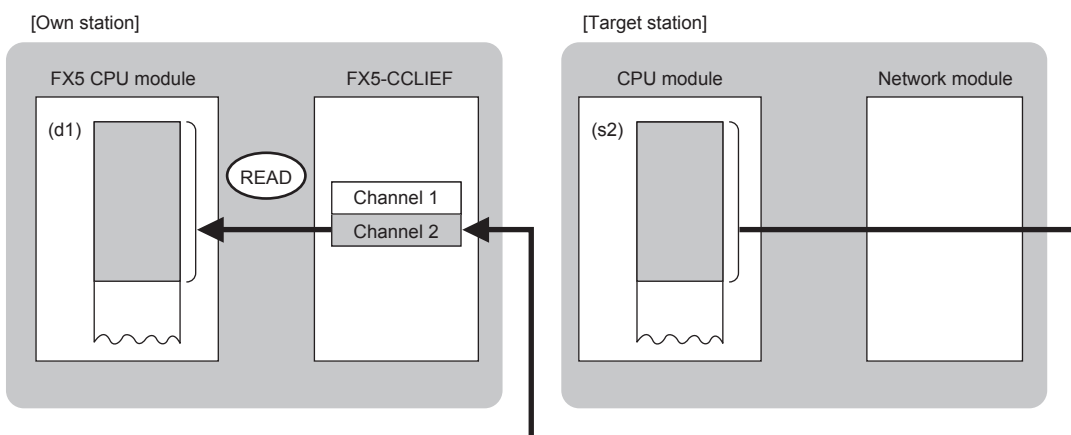

- When executing multiple link dedicated instructions concurrently, be careful not to overlap the channels of the link dedicated instructions. Multiple link dedicated instructions specifying the same channel cannot be used concurrently.
- The execution of the GP.READ instruction and whether it has been completed normally or completed with an error can be checked with the completion device (d2) or completion status indication device (d2)+1.

Device	Operation
Completion device (d2)	The device turns on during the END processing for the scan in which the GP.READ instruction is completed, and turns off during the next END processing.
Completion status indication device (d2)+1	The device turns on or off depending on the completion status of the GP.READ instruction. When completed normally: The device does not change (remains off). When completed with an error: The device turns on during the END processing for the scan in which the GP.READ instruction is completed, and turns off during the next END processing.

• The following figure shows the execution timing of the GP.READ instruction.

■ When completed normally

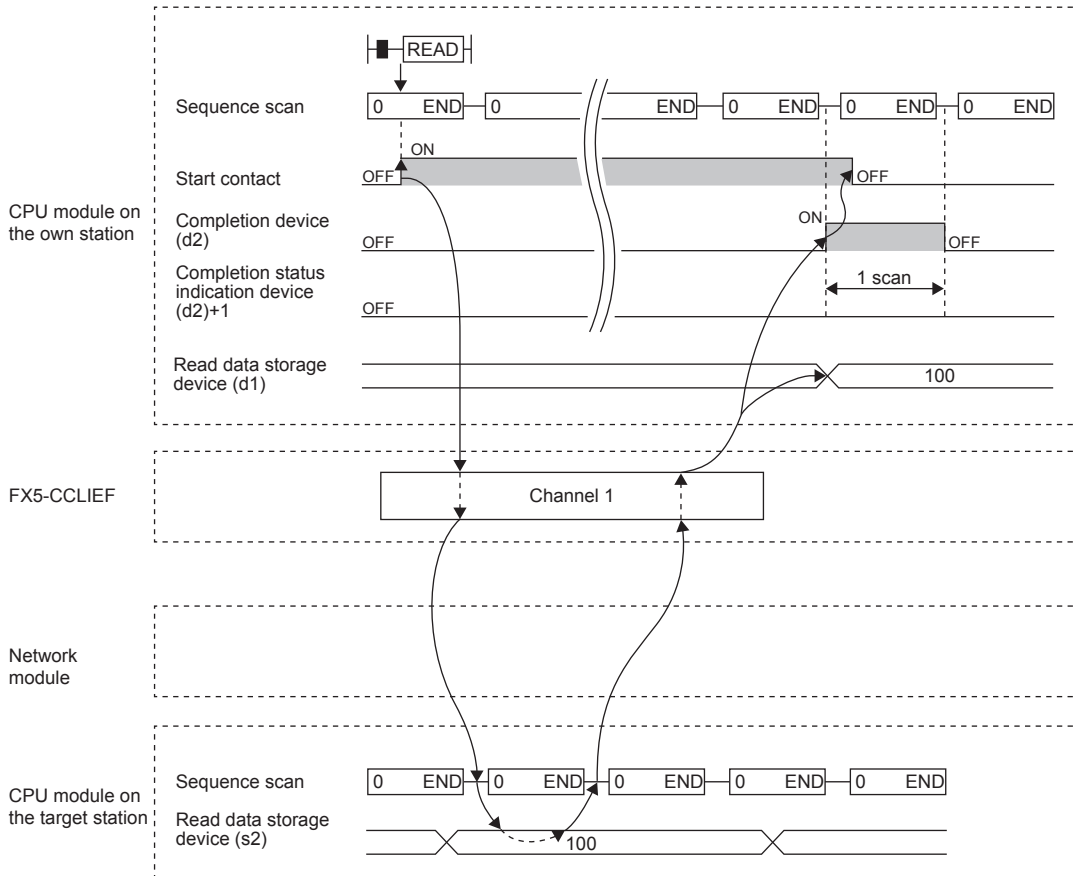

■ When completed with an error

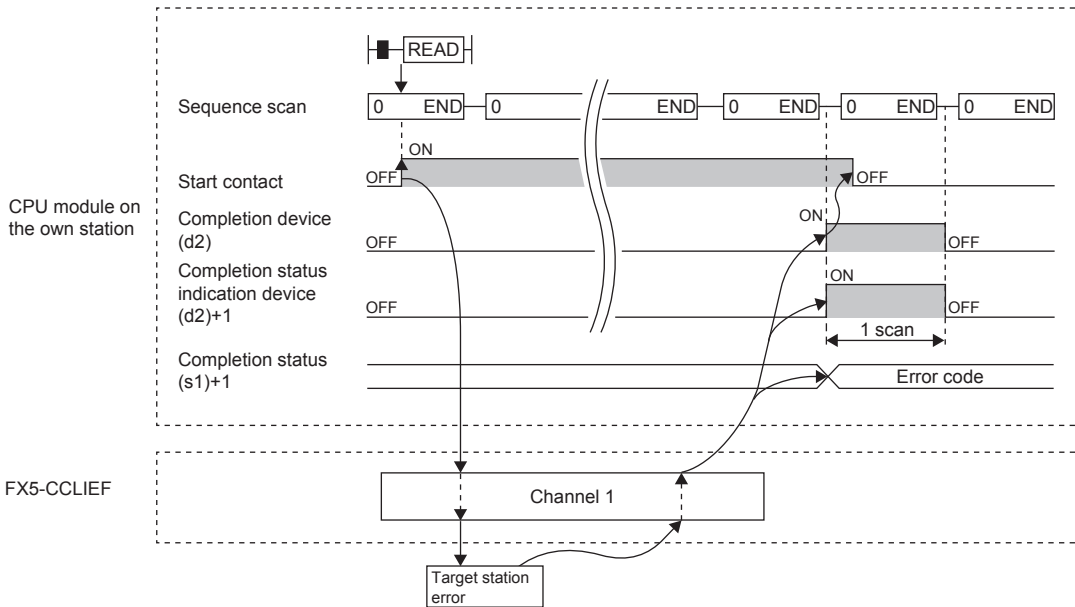

Operation error

Error code ((s1)+1)	Description
D000H to DFFFH	Refer to Page 120 List of Error Codes.

Program example

The following program is for reading data of D250 to D254 of station No. 4 (target station) into D700 to D704 of station No. 1 (own station) when M102 is turned on.

- System configuration

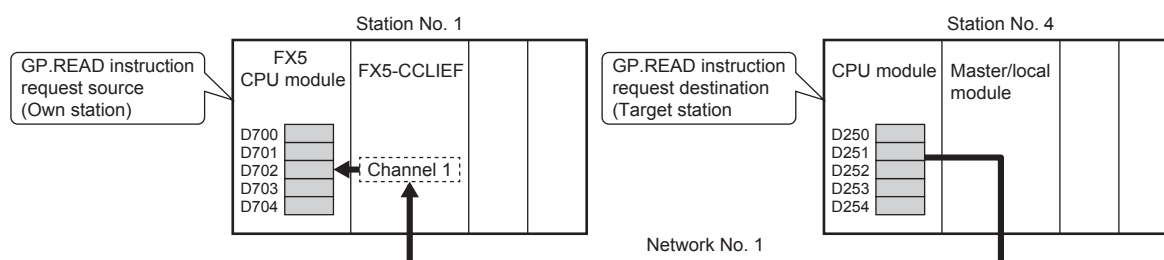

- Devices used

Device	Description
SB0047	Baton pass status of own station
M100	Control data set command
M102	Start contact
M105	Completion device
M106	Completion status indication device
D200 to D217	Control data of the GP.READ instruction (For the set value, refer to the following figure.)
D700 to D704	Read data storage device (station No. 1)

- Control data

Device	Item	Set value
(s1)+0	D200	Error completion type 0080H Set data for error completion.
(s1)+1	D201	Completion status Setting not required
(s1)+2	D202	Own station channel 1
(s1)+3	D203	Target station CPU type 0000H Addressed to target station CPU (control CPU)
(s1)+4	D204	Target network number 1
(s1)+5	D205	Target station number 4
(s1)+6	D206	Not used —
(s1)+7	D207	Number of resends 5 times
(s1)+8	D208	Arrival monitoring time 0 (10 seconds)
(s1)+9	D209	Read data length 5 words
(s1)+10	D210	Not used —
(s1)+11	D211	Clock set flag Setting not required
(s1)+12 to (s1)+15	D212 to D215	Clock data (Set only in an abnormal state)
(s1)+16	D216	Error detection network number
(s1)+17	D217	Error-detected station number

• Program

Write the following program to the FX5 CPU module of station No. 1.

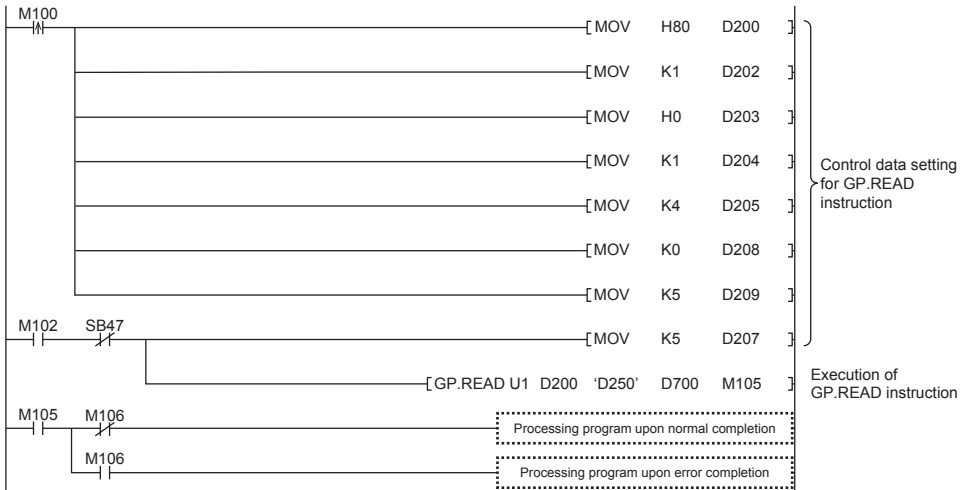

■Program using module FB

Program as follows when using the module FB.

- Devices used

Device	Description
SB0047	Baton pass status of own station
M100	Setting command of module FB
M102	Execution command of module FB
M104 to M106	Bit-type input output label for module FB (Refer to the following table for the setting.)
D202, D204, D205, D209 and D218	Word-type input output label for module FB (Refer to the following table for the setting.)
D700 to D704	Read data storage device (station No. 1)

- Module FB instance name

Name of module FB	Instance name
M+FX5CCLIEF_DeviceRead	DeviceRead

- FX5-CCLIEF module label

Module label name	Module No.
FX5CCLIEF_1	No.1

- Label to be used

Label name	Item	Setting value/setting device
■Input label		
i_bEN	Execution command	—
i_stModule	Module label	FX5CCLIEF_1
i_u2TargetAddress	First word: target station network number	1 (D204)
	Second word: target station number	4 (D205)
i_uDataLength	Read data length	5 words (D209)
i_s32TargetDevice	Target station read device	D250
i_uChannel	Own station channel	1 (D202)
■Output label		
o_bENO	Execution status	M104
o_bOK	Normal completion	M105
o_bErr	Abnormal end	M106
o_uErrId	Error code	D218
o_uReadData	Read data storage device	D700
■Public label		
pbi_uCPU_Type	Target station CPU type	0000H
pbi_uTimeUnit	Arrival monitoring time unit	0 (10 seconds)
pbi_uResendCountMax	Maximum number of resends	5 times

• Program

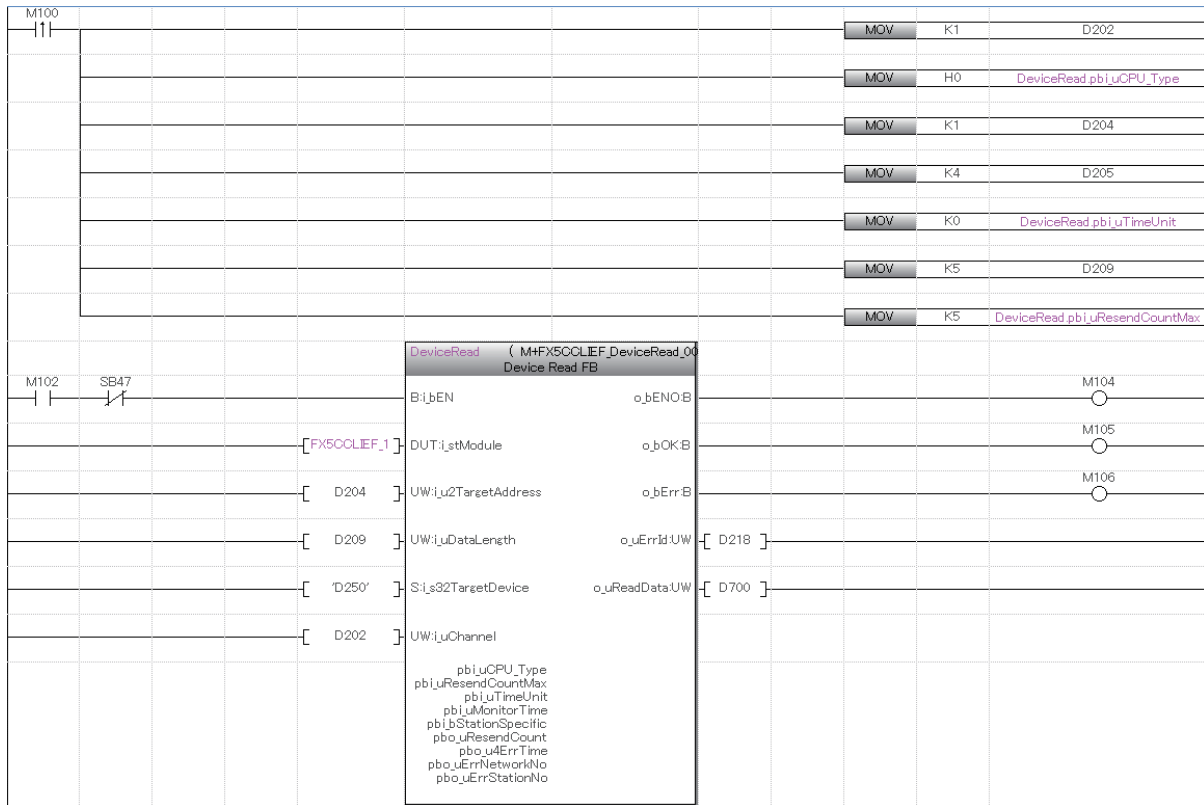

Add the processing program when completed successfully and completed with an error after the program above.

Reading data from the programmable controller on another station (with notification)

GP.SREAD

This instruction reads data from a device in another station programmable controller. (In units of words)

After the data reading is completed by the GP.SREAD instruction, the device of the other station is turned on. The other station can recognize that data has been read by the GP.SREAD instruction.

Ladder	ST
	<pre>ENO:=GP_SREAD(EN,Un,s1,s2,d1,d2,d3);</pre>

FBD/LD

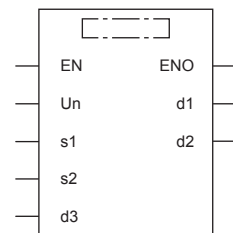

("GP_SREAD" enters □.)

Setting data

■Description, range, data type

Operand	Description	Range	Data type	Data type (label)
(U) ^{*1}	Position number of the module connected	<ul style="list-style-type: none"> ■FX5UJ CPU module 1H to 8H ■FX5U/FX5UC CPU module 1H to 10H 	16-bit unsigned binary	ANY16
(s1)	Own station head device where control data is stored	Refer to Page 56 Control data.	Device name	ANY16 ^{*4}
(s2)	Target station head device where the data to be read is stored	—	Character string ^{*2}	ANYSTRING_SINGLE ^{*2}
(d1)	Own station head device for storing the read data ^{*3}	—	Device name	ANY16 ^{*4}
(d2)	Own station device to be turned on for one scan when the instruction completes. (d2)+1 also turns on when the instruction completes with an error.	—	Bit	ANYBIT_ARRAY (Number of elements: 2)
(d3)	Target station device to be turned on for one scan when the instruction completes (The target station can recognize that data has been read from another station.)	—	Character string ^{*2}	ANYSTRING_SINGLE ^{*2}
EN	Execution condition	—	Bit	BOOL
ENO	Execution result	—	Bit	BOOL

*1 In the case of the ST language and the FBD/LD language, U displays as Un.

*2 For the specifications of the string data to be specified, refer to the following.

Page 45 Specifications of character string data specified by link dedicated instructions)

*3 The continuous area specified by the read data length (s1)+9 is required.

*4 Digit specified bit type label cannot be used.

■Applicable devices

Operand	Bit	Word			Double word		Indirect specification	Constant			Others (U)
	X, Y, M, L, SM, F, B, SB, S	T, ST, C, D, W, SD, SW, R	U□\G□	Z	LC	LZ		K, H	E	\$	
(U)	—	○	—	—	—	—	○	○	—	—	○
(s1)	—	○	—	—	—	—	○	—	—	—	—
(s2)	—	—	—	—	—	—	—	—	—	○	—
(d1)	—	○	—	—	—	—	○	—	—	—	—
(d2)	○*1	○*2	—	—	—	—	—	—	—	—	—
(d3)	—	—	—	—	—	—	—	—	—	○	—

*1 S cannot be used.

*2 T, ST, and C cannot be used.

■Control data

Device	Item	Description	Setting range	Set by
(s1)+0	Error completion type	b15 ... b8 b7 b6 ... b0 <div style="border: 1px solid black; padding: 2px; display: inline-block;"> 0 (1) 0 </div> <p>(1) Error completion type (bit 7) Specify whether to set data at completion with an error.</p> <ul style="list-style-type: none"> • 0: Do not set data in (s1)+11 and later at completion with an error. • 1: Set data in (s1)+11 and later at completion with an error. 	0000H 0080H	User
(s1)+1	Completion status	The instruction completion status is stored. • 0: Normal • Other than 0: Error (error code)	—	System
(s1)+2	Own station channel	Specify the channel to be used by own station.	1, 2	User
(s1)+3	Target station CPU type	Specify the CPU type of the target station. • 0000H: Addressed to target station CPU (control CPU) • 03D0H: Addressed to control system CPU • 03D1H: Addressed to standby system CPU • 03D2H: Addressed to system A CPU • 03D3H: Addressed to system B CPU • 03E0H: Addressed to multiple CPU No. 1 • 03E1H: Addressed to multiple CPU No. 2 • 03E2H: Addressed to multiple CPU No. 3 • 03E3H: Addressed to multiple CPU No. 4 • 03FFH: Addressed to target station CPU (control CPU)	0000H 03D0H to 03D3H 03E0H to 03E3H 03FFH	User
(s1)+4	Target network number	Specify the network number (1 to 239) of the target station.	1 to 239	User
(s1)+5	Target station number	Specify the station number of the target station. • 125: Master station • 126: Master operating station • 1 to 120: Local station, intelligent device station, submaster station	1 to 120, 125, 126	User
(s1)+6	Not used	—	—	—
(s1)+7	Number of resends	■Before instruction execution Specify the number of resends to be performed if the instruction is not completed within the monitoring time specified by (s1)+8. ■At completion of instruction The number of resends performed (result) is stored.	0 to 15	User/ system
(s1)+8	Arrival monitoring time	Specify the monitoring time until completion of processing. If processing is not completed within the monitoring time, the request is resent by the number of resends specified in (s1)+7. • 0: 10 seconds • 1 to 32767: 1 to 32767 seconds	0 to 32767	User
(s1)+9	Read data length	Specify the number of words to be read. • 1 to 960 (words) (When reading data from QnACPU: 1 to 480 (words))	1 to 960	User
(s1)+10	Not used	—	—	—

Device	Item	Description	Setting range	Set by
(s1)+11	Clock setting flag	The validity status (valid or invalid) of the data in (s1)+12 and later is stored. Note that the data in (s1)+12 and later is not cleared even when the instruction is completed successfully. • 0: Invalid • 1: Valid	—	System
(s1)+12	Clock data (Set only in an abnormal state)	Upper 8 bits: Month (01H to 12H) Lower 8 bits: Lower 2 digits of year (00H to 99H)	—	System
(s1)+13		Upper 8 bits: Hour (00H to 23H) Lower 8 bits: Day (01H to 31H)	—	System
(s1)+14		Upper 8 bits: Second (00H to 59H) Lower 8 bits: Minute (00H to 59H)	—	System
(s1)+15		Upper 8 bits: Upper 2 digits of the year (00H to 99H) Lower 8 bits: Day of the week (00H (Sun.) to 06H (Sat.))	—	System
(s1)+16	Error detection network number*1	The network number of the station in which an error was detected is stored. • 1 to 239 (Network number)	—	System
(s1)+17	Error-detected station number*1	The station number of the station where an error was detected is stored. (No information is stored if an error is detected in the own station.) • 125: Master station • 1 to 120: Local station, intelligent device station, submaster station	—	System

*1 If completion status ((s1)+1) is "Channel in use (dedicated instruction) (error codes: D25AH and D25BH)", data is not stored.

Point

The number of resends (s1)+7 must be set every time the instruction is executed.

Processing details

- The instruction reads data by the specified number of words ((s1)+9) from the target station head device (s2) into the own station word device (after (d1)). Specify the target stations in control data ((s1)+4) and ((s1)+5). Upon completion of reading the device data specified by (s2), the completion device specified by (d2) turns on. Upon completion of reading the device data specified by (s2), the completion device specified by (d2) turns on. In target station, upon completion of sending the device data specified by (s2), the device specified by (d3) turns on.
- For the target stations that can be specified, refer to the following.

Page 44 Target networks and target station types

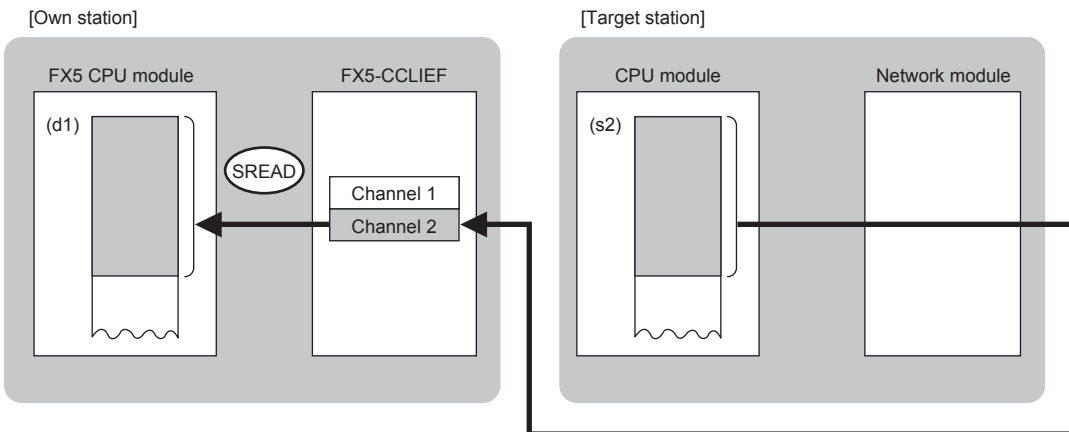

- When executing multiple link dedicated instructions concurrently, be careful not to overlap the channels of the link dedicated instructions. Multiple link dedicated instructions specifying the same channel cannot be used concurrently.
- The execution of the GP.SREAD instruction and whether it has been completed normally or completed with an error can be checked with the completion device (d2) or completion status indication device (d2)+1.

Device	Operation
Completion device (d2)	The device turns on during the END processing for the scan in which the GP.SREAD instruction is completed, and turns off during the next END processing.
Completion status indication device (d2)+1	The device turns on or off depending on the completion status of the GP.SREAD instruction. When completed normally: The device does not change (remains off). When completed with an error: The device turns on during the END processing for the scan in which the GP.SREAD instruction is completed, and turns off during the next END processing.

Program example

The following program is for reading data of D250 to D254 of station No. 4 (target station) into D700 to D704 of station No. 1 (own station) when M102 is turned on and for turning on Y60 of the target station when the read notification device (d3) is turned on in the target station.

- System configuration

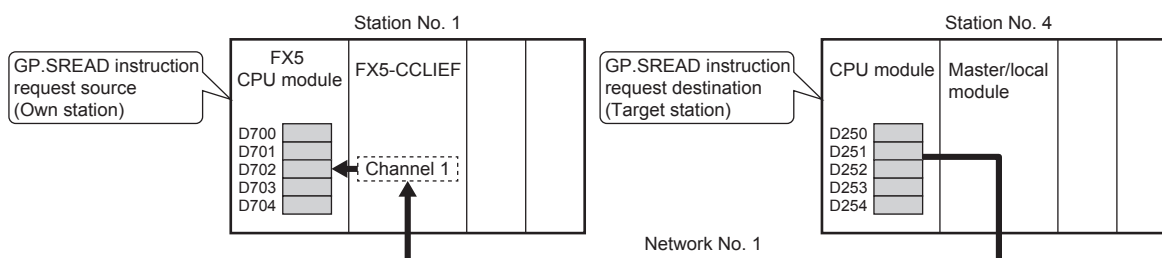

- Devices used

Device	Description
■Device used in the own station (station No. 1)	
SB0047	Baton pass status of own station
M100	Control data set command
M102	Start contact
M105	Completion device
M106	Completion status indication device
D200 to D217	Control data of the GP.SREAD instruction (For the set value, refer to the following figure.)
D700 to D704	Read data storage device (station No. 1)
■Device used in the target station (station No. 4)	
M107	Read notification device used in the target station (station No. 4)
Y60	Read completion device used in the target station (station No. 4)

- Control data

Device	Item	Set value
(s1)+0	D200	Error completion type 0080H Set data for error completion.
(s1)+1	D201	Completion status Setting not required
(s1)+2	D202	Own station channel 1
(s1)+3	D203	Target station CPU type 0000H Addressed to target station CPU (control CPU)
(s1)+4	D204	Target network number 1
(s1)+5	D205	Target station number 4
(s1)+6	D206	Not used —
(s1)+7	D207	Number of resends 5 times
(s1)+8	D208	Arrival monitoring time 0 (10 seconds)
(s1)+9	D209	Read data length 5 words
(s1)+10	D210	Not used —
(s1)+11	D211	Clock set flag Setting not required
(s1)+12 to (s1)+15	D212 to D215	Clock data (Set only in an abnormal state)
(s1)+16	D216	Error detection network number
(s1)+17	D217	Error-detected station number

• Program

Write the following program to the FX5 CPU module of station No. 1.

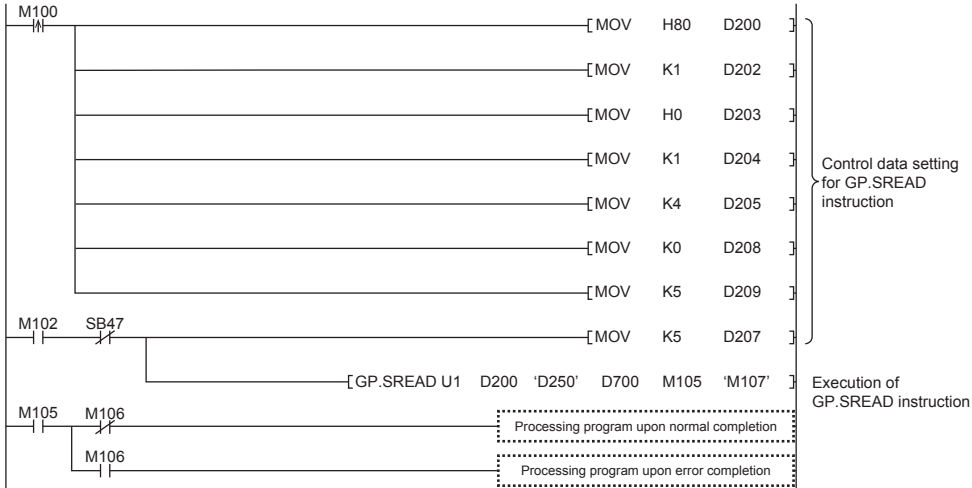

Write the following program to the CPU module of the target station of station No. 4.



Writing data to the programmable controller on another station

GP.WRITE

This instruction writes data to the device in another station programmable controller. (In units of words)

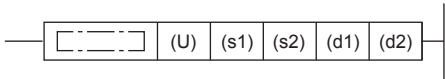
Ladder	ST
	<pre>ENO:=GP_WRITE(EN,Un,s1,s2,d1,d2);</pre>

FBD/LD

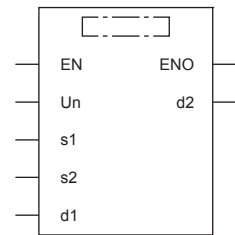

("GP_WRITE" enters □.)

Setting data

■Description, range, data type

Operand	Description	Range	Data type	Data type (label)
(U) ^{*1}	Position number of the module connected	<ul style="list-style-type: none"> ■FX5UJ CPU module 1H to 8H ■FX5U/FX5UC CPU module 1H to 10H 	16-bit unsigned binary	ANY16
(s1)	Own station head device where control data is stored	Refer to  Page 62 Control data.	Device name	ANY16 ^{*4}
(s2)	Own station head device where the data to be written is stored	—	Device name	ANY16 ^{*4}
(d1)	Target station head device where data is to be written ^{*2}	—	Character string ^{*3}	ANYSTRING_SINGL E ^{*3}
(d2)	Own station device to be turned on for one scan when the instruction completes. (d2)+1 also turns on when the instruction completes with an error.	—	Bit	ANYBIT_ARRAY (Number of elements: 2)
EN	Execution condition	—	Bit	BOOL
ENO	Execution result	—	Bit	BOOL

*1 In the case of the ST language and the FBD/LD language, U displays as Un.

*2 The continuous area specified by the write data length (s1)+9 is required.

*3 For the specifications of the string data to be specified, refer to the following.

( Page 45 Specifications of character string data specified by link dedicated instructions)

*4 Digit specified bit type label cannot be used.

■Applicable devices

Operand	Bit	Word			Double word		Indirect specification	Constant			Others (U)
	X, Y, M, L, SM, F, B, SB, S	T, ST, C, D, W, SD, SW, R	U□\G□	Z	LC	LZ		K, H	E	\$	
(U)	—	○	—	—	—	—	○	○	—	—	○
(s1)	—	○	—	—	—	—	○	—	—	—	—
(s2)	—	○	—	—	—	—	○	—	—	—	—
(d1)	—	—	—	—	—	—	—	—	—	○	—
(d2)	○ ^{*1}	○ ^{*2}	—	—	—	—	—	—	—	—	—

*1 S cannot be used.

*2 T, ST, and C cannot be used.

Control data

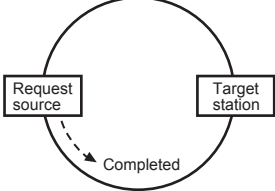
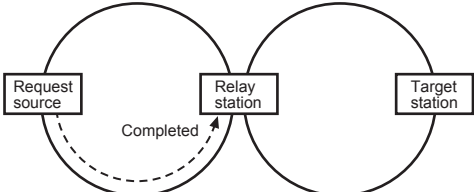
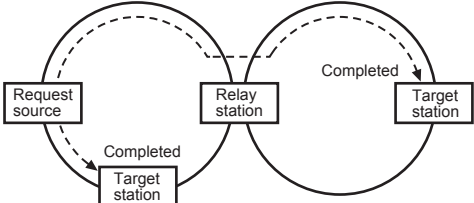
Device	Item	Description	Setting range	Set by				
(s1)+0	Execution/error completion type	<p>b15 ... b8 b7 ... b0</p> <table border="1" style="margin-left: 20px;"> <tr> <td style="width: 40px;">0</td> <td style="width: 40px;">(2)</td> <td style="width: 40px;">0</td> <td style="width: 40px;">(1)</td> </tr> </table> <p>(1) Execution type (bit 0)</p> <ul style="list-style-type: none"> • 0: No arrival acknowledgment <p>When the target station is in the own network: Completed when data has been sent from the own station.</p>  <p>When the target station is in another network: Completed when data has arrived the relay station of the own network.</p>  <ul style="list-style-type: none"> • 1: Arrival acknowledgment used <p>Completed when data has been written in the target station.</p>  <p>(2) Error completion type (bit 7)</p> <p>Specify whether to set data at completion with an error.</p> <ul style="list-style-type: none"> • 0: Do not set data in (s1)+11 and later at completion with an error. • 1: Set data in (s1)+11 and later at completion with an error. 	0	(2)	0	(1)	0000H 0001H 0080H 0081H	User
0	(2)	0	(1)					
(s1)+1	Completion status	<p>The instruction completion status is stored.</p> <ul style="list-style-type: none"> • 0: Normal • Other than 0: Error (error code) 	—	System				
(s1)+2	Own station channel	Specify the channel to be used by own station.	1, 2	User				
(s1)+3	Target station CPU type	<p>Specify the CPU type of the target station.</p> <ul style="list-style-type: none"> • 0000H: Addressed to target station CPU (control CPU) • 03D0H: Addressed to control system CPU • 03D1H: Addressed to standby system CPU • 03D2H: Addressed to system A CPU • 03D3H: Addressed to system B CPU • 03E0H: Addressed to multiple CPU No. 1 • 03E1H: Addressed to multiple CPU No. 2 • 03E2H: Addressed to multiple CPU No. 3 • 03E3H: Addressed to multiple CPU No. 4 • 03FFH: Addressed to target station CPU (control CPU) 	0000H 03D0H to 03D3H 03E0H to 03E3H 03FFH	User				
(s1)+4	Target network number	Specify the network number (1 to 239) of the target station.	1 to 239	User				

Device	Item	Description	Setting range	Set by
(s1)+5	Target station number	Specify the station number of the target station. (1) Station number specification • 125: Master station • 126: Master operating station • 1 to 120: Local station, intelligent device station, submaster station (2) Group number specification • 0081H to 00A0H: All stations with group numbers 0001H to 0020H (Can be set when the execution type specified by (s1)+0 is "0: No arrival acknowledgment") (3) All-station specification • 00FFH: All stations of target network number (broadcast (excluding the own station)) (Can be set when the execution type specified by (s1)+0 is "0: No arrival acknowledgment") If the instruction is executed with group or all stations specification, specify "0000H" or "03FFH" for the target station's CPU type ((s1)+3).	Station No.: 1 to 120, 125, 126 Group number specification: 0081H to 00A0H All-station specification: 00FFH	User
(s1)+6	Not used	—	—	—
(s1)+7	Number of resends	Effective when the execution type specified by (s1)+0 is "1: Arrival acknowledgment used". ■Before instruction execution Specify the number of resends to be performed if the instruction is not completed within the monitoring time specified by (s1)+8. ■At completion of instruction The number of resends performed (result) is stored.	0 to 15	User/ system
(s1)+8	Arrival monitoring time	Effective when the execution type specified by (s1)+0 is "1: Arrival acknowledgment used". Specify the monitoring time until completion of processing. If processing is not completed within the monitoring time, the request is resent by the number of resends specified in (s1)+7. • 0: 10 seconds • 1 to 32767: 1 to 32767 seconds	0 to 32767	User
(s1)+9	Write data length	Specify the number of words to be written. • 1 to 960 (words) (When writing data to QnACPU: 1 to 480 (words))	1 to 960	User
(s1)+10	Not used	—	—	—
(s1)+11	Clock setting flag	The validity status (valid or invalid) of the data in (s1)+12 and later is stored. Note that the data in (s1)+12 and later is not cleared even when the instruction is completed successfully. • 0: Invalid • 1: Valid	—	System
(s1)+12	Clock data (Set only in an abnormal state)	Upper 8 bits: Month (01H to 12H) Lower 8 bits: Lower 2 digits of year (00H to 99H)	—	System
(s1)+13		Upper 8 bits: Hour (00H to 23H) Lower 8 bits: Day (01H to 31H)	—	System
(s1)+14		Upper 8 bits: Second (00H to 59H) Lower 8 bits: Minute (00H to 59H)	—	System
(s1)+15		Upper 8 bits: Upper 2 digits of the year (00H to 99H) Lower 8 bits: Day of the week (00H (Sun.) to 06H (Sat.))	—	System
(s1)+16		Error detection network number* ¹	The network number of the station in which an error was detected is stored. (No information is stored if an error is detected in the own station.) • 1 to 239 (Network number)	—
(s1)+17	Error-detected station number* ¹	The station number of the station where an error was detected is stored. (No information is stored if an error is detected in the own station.) • 125: Master station • 1 to 120: Local station, intelligent device station, submaster station	—	System

*1 If completion status ((s1)+1) is "Channel in use (dedicated instruction) (error codes: D25AH and D25BH)", data is not stored.

- When a number from 1 to 120 is specified for the target station number, the GP.WRITE instruction should be executed with the execution type set to "Arrival acknowledgment used" to improve data reliability. When a number from 81H to A0H or FFH is specified for the target station number, the GP.WRITE instruction should be executed with the execution type set to "No arrival acknowledgment".
- When performing device writing to the same station from multiple stations, do not overlap the write timing. When the execution type is set to "No arrival acknowledgment", successful completion results in the write source station if communication is completed successfully even when the sending data contains an error. Also, even when the sending data is normal, a timeout results in the write source station if the GP.WRITE instruction is executed for the same station from multiple stations.
- The number of resends (s1)+7 must be set every time the instruction is executed.

Processing details

- The instruction writes data by the specified number of words ((s1)+9) from the own station head device (s2) into the target station word devices. Specify the target stations in control data ((s1)+4) and ((s1)+5). Upon completion of writing device data to target station, the completion device specified by (d2) turns on.
- For the target stations that can be specified, refer to the following.

 Page 44 Target networks and target station types

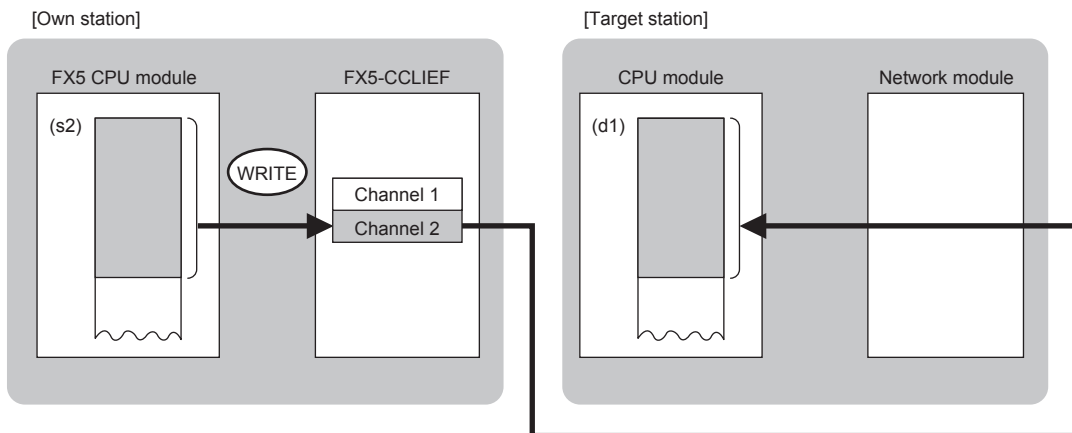

- When executing multiple link dedicated instructions concurrently, be careful not to overlap the channels of the link dedicated instructions. Multiple link dedicated instructions specifying the same channel cannot be used concurrently.
- The execution of the GP.WRITE instruction and whether it has been completed normally or completed with an error can be checked with the completion device (d2) or completion status indication device (d2)+1.

Device	Operation
Completion device (d2)	The device turns on during the END processing for the scan in which the GP.WRITE instruction is completed, and turns off during the next END processing.
Completion status indication device (d2)+1	The device turns on or off depending on the completion status of the GP.WRITE instruction. When completed normally: The device does not change (remains off). When completed with an error: The device turns on during the END processing for the scan in which the GP.WRITE instruction is completed, and turns off during the next END processing.

• The following figure shows the execution timing of the GP.WRITE instruction.

■ When completed normally

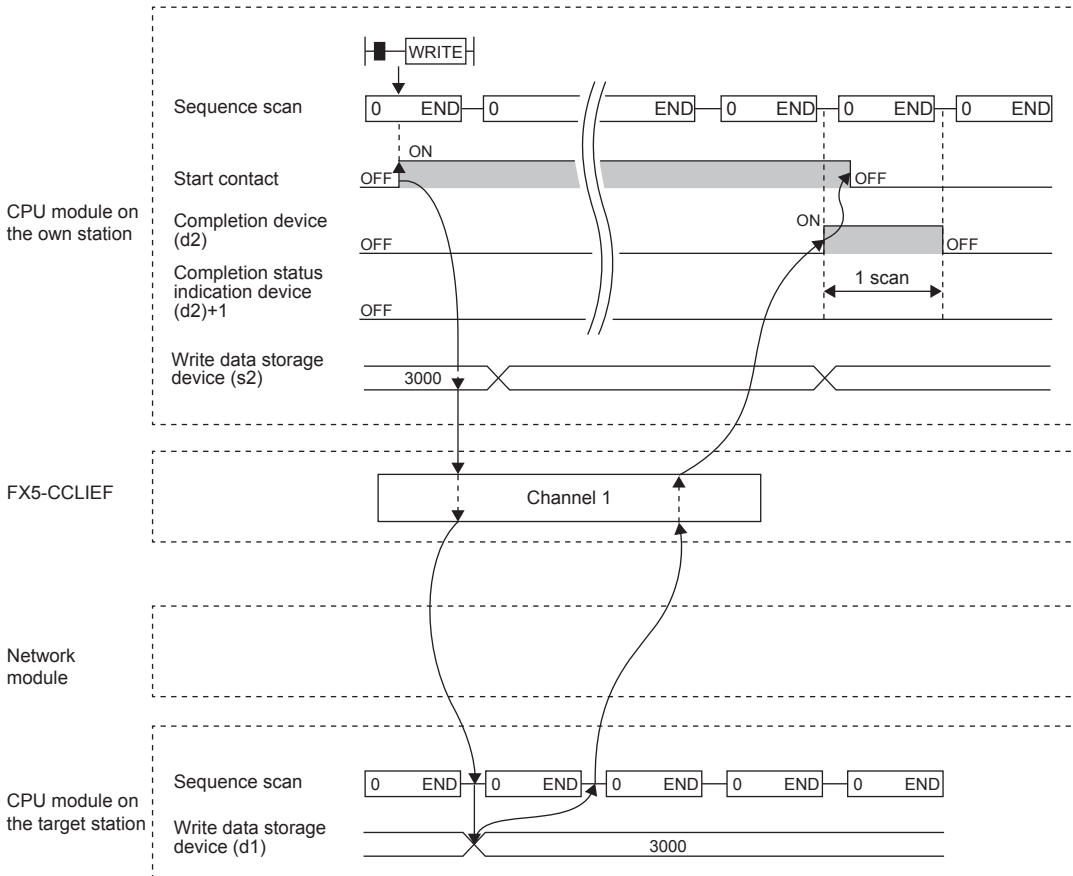

■ When completed with an error

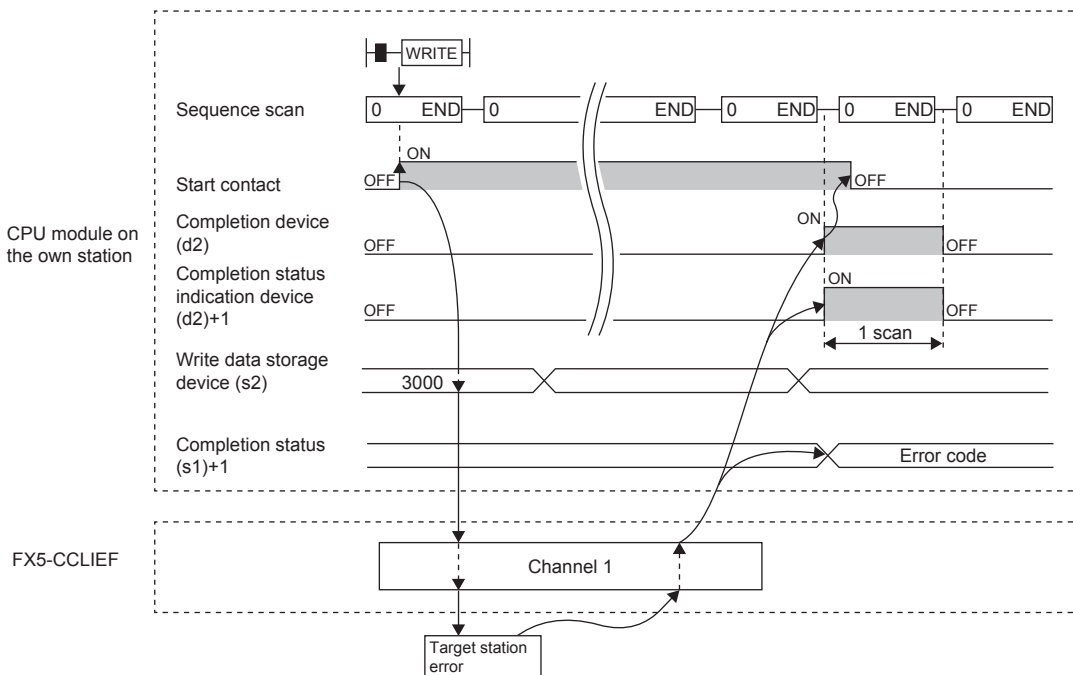

• Write processing is performed only once on the rising edge when the write command turns on.

Operation error

Error code ((s1)+1)	Description
D000H to DFFFH	Refer to Page 120 List of Error Codes .

Program example

The following program is for writing data of D750 to D753 of station No. 2 (own station) into D300 to D303 of station No. 3 (target station) when M112 is turned on.

- System configuration

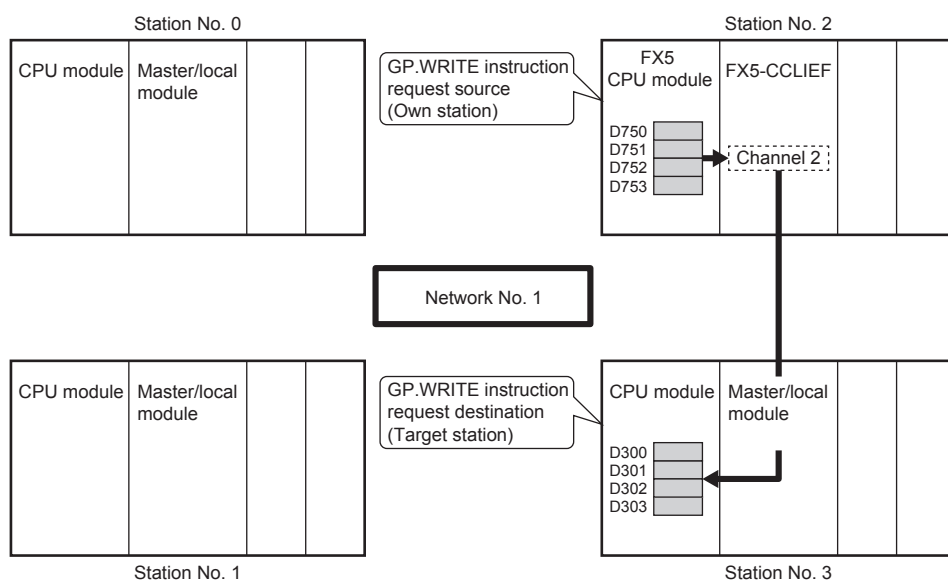

- Devices used

Device	Description
SB0047	Baton pass status of own station
M110	Control data set command
M111	Write data setting command
M112	Start contact
M115	Completion device
M116	Completion status indication device
D220 to D237	Control data of the GP.WRITE instruction (For the set value, refer to the following figure.)
D750 to D753	Write data storage device (station No. 2)

- Control data

Device	Item	Set value
(s1)+0	D220	Execution/error completion type 0081H • Arrival acknowledgment used • Set data for error completion.
(s1)+1	D221	Completion status Setting not required
(s1)+2	D222	Own station channel 2
(s1)+3	D223	Target station CPU type 0000H Addressed to target station CPU (control CPU)
(s1)+4	D224	Target network number 1
(s1)+5	D225	Target station number 3
(s1)+6	D226	Not used —
(s1)+7	D227	Number of resends 5 times
(s1)+8	D228	Arrival monitoring time 0 (10 seconds)
(s1)+9	D229	Write data length 4 words
(s1)+10	D230	Not used —
(s1)+11	D231	Clock set flag Setting not required
(s1)+12 to (s1)+15	D232 to D235	Clock data (Set only in an abnormal state)
(s1)+16	D236	Error detection network number
(s1)+17	D237	Error-detected station number

• Program

Write the following program to the FX5 CPU module of station No. 2.

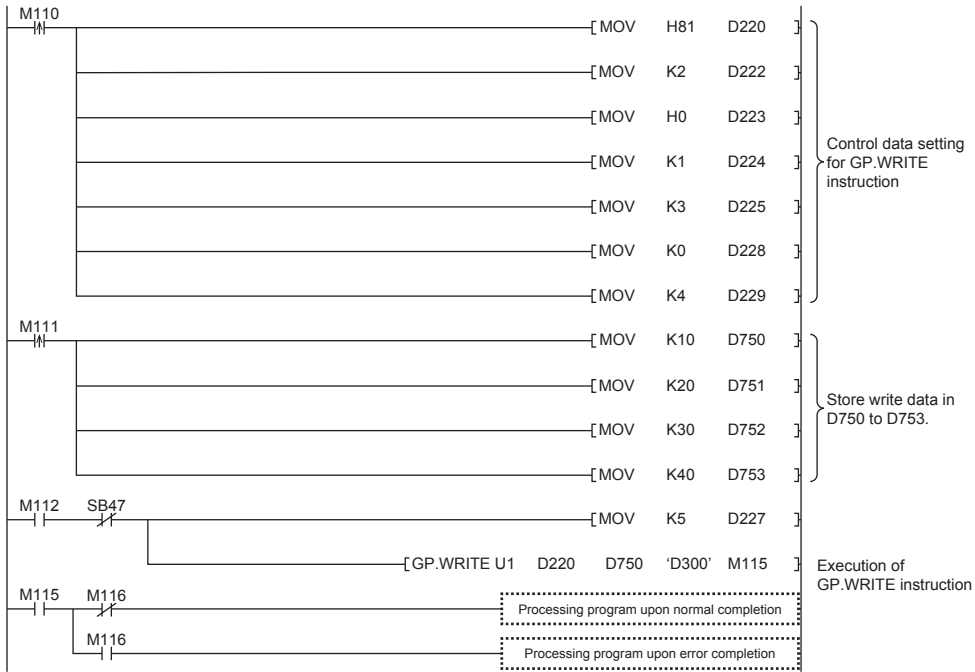

■Program using module FB

Program as follows when using the module FB

- Devices used

Device	Description
SB0047	Baton pass status of own station
M110	Setting command of module FB
M112	Execution command of module FB
M114 to M116	Bit-type input output label for module FB (Refer to the following table for the setting.)
D222, D224, D225, D229 and D238	Word-type input output label for module FB (Refer to the following table for the setting.)
D750 to D753	Write data storage device (station No. 2)

- Module FB instance name

Name of module FB	Instance name
M+FX5CCLIEF_DeviceWrite	DeviceWrite

- FX5-CCLIEF module label

Module label name	Module No.
FX5CCLIEF_1	No.1

- Label to be used

Label name	Item	Setting value/setting device
■Input label		
i_bEN	Execution command	—
i_stModule	Module label	FX5CCLIEF_1
i_u2TargetAddress	First word: target station network number	1 (D224)
	Second word: Target station number	3 (D225)
i_uDataLength	Write data length	4 words (D229)
i_uWriteData	Write data storage device	D750
i_s32TargetDevice	Target station write device	D300
i_uChannel	Own station channel	2 (D222)
■Output label		
o_bENO	Execution status	M114
o_bOK	Normal completion	M115
o_bErr	Abnormal end	M116
o_uErrId	Error code	D238
■Public label		
pbi_uCPU_Type	Target station CPU type	0000H
pbi_uMonitorTime	Arrival monitoring time	0 (10 seconds)
pbi_uResendCountMax	Maximum number of resends	5 times

Writing data to the programmable controller on another station (with notification)

GP.SWRITE

This instruction writes data to the device in another station programmable controller. (In units of words)

After the data writing is completed by the GP.SWRITE instruction, the device of the other station is turned on. The other station can recognize that data has been written by the GP.SWRITE instruction.

Ladder	ST
	<pre>ENO:=GP_SWRITE(EN,Un,s1,s2,d1,d2,d3);</pre>

FBD/LD

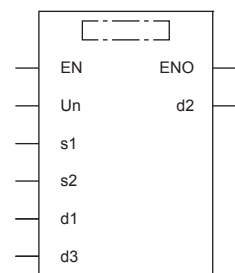

("GP_SWRITE" enters □.)

Setting data

■Description, range, data type

Operand	Description	Range	Data type	Data type (label)
(U) ^{*1}	Position number of the module connected	<ul style="list-style-type: none"> ■FX5UJ CPU module 1H to 8H ■FX5U/FX5UC CPU module 1H to 10H 	16-bit unsigned binary	ANY16
(s1)	Own station head device where control data is stored	Refer to Page 71 Control data.	Device name	ANY16 ^{*4}
(s2)	Own station head device where the data to be written is stored	—	Device name	ANY16 ^{*4}
(d1)	Target station head device where data is to be written ^{*2}	—	Character string ^{*3}	ANYSTRING_SINGL E ^{*3}
(d2)	Own station device to be turned on for one scan when the instruction completes. (d2)+1 also turns on when the instruction completes with an error.	—	Bit	ANYBIT_ARRAY (Number of elements: 2)
(d3)	Target station device to be turned on for one scan when the instruction completes (enabling the target station to recognize that data has been written from another station)	—	Character string ^{*3}	ANYSTRING_SINGL E ^{*3}
EN	Execution condition	—	Bit	BOOL
ENO	Execution result	—	Bit	BOOL

*1 In the case of the ST language and the FBD/LD language, U displays as Un.

*2 The continuous area specified by the write data length (s1)+9 is required.

*3 For the specifications of the string data to be specified, refer to the following.

(Page 45 Specifications of character string data specified by link dedicated instructions)

*4 Digit specified bit type label cannot be used.

■Applicable devices

Operand	Bit	Word			Double word		Indirect specification	Constant			Others (U)
	X, Y, M, L, SM, F, B, SB, S	T, ST, C, D, W, SD, SW, R	U□\G□	Z	LC	LZ		K, H	E	\$	
(U)	—	○	—	—	—	—	○	○	—	—	○
(s1)	—	○	—	—	—	—	○	—	—	—	—
(s2)	—	○	—	—	—	—	○	—	—	—	—
(d1)	—	—	—	—	—	—	—	—	—	○	—
(d2)	○*1	○*2	—	—	—	—	—	—	—	—	—
(d3)	—	—	—	—	—	—	—	—	—	○	—

*1 S cannot be used.

*2 T, ST, and C cannot be used.

■Control data

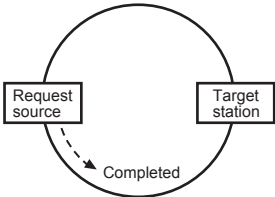
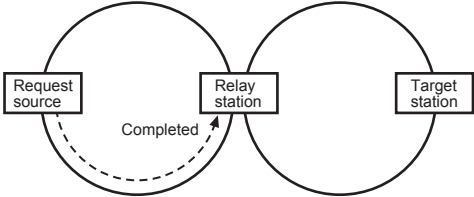
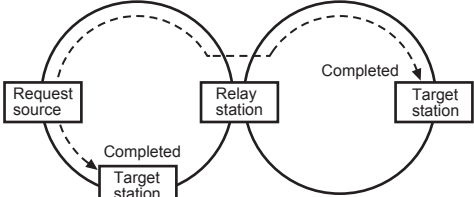
Device	Item	Description	Setting range	Set by
(s1)+0	Execution/error completion type	<p>b15 ... b8 b7 ... b0</p> <p>0 (2) 0 (1)</p> <p>(1) Execution type (bit 0)</p> <ul style="list-style-type: none"> • 0: No arrival acknowledgment <p>When the target station is in the own network: Completed when data has been sent from the own station.</p>  <p>When the target station is in another network: Completed when data has arrived the relay station of the own network.</p>  <ul style="list-style-type: none"> • 1: Arrival acknowledgment used <p>Completed when data has been written in the target station.</p>  <p>(2) Error completion type (bit 7)</p> <p>Specify whether to set data at completion with an error.</p> <ul style="list-style-type: none"> • 0: Do not set data in (s1)+11 and later at completion with an error. • 1: Set data in (s1)+11 and later at completion with an error. 	0000H 0001H 0080H 0081H	User
(s1)+1	Completion status	<p>The instruction completion status is stored.</p> <ul style="list-style-type: none"> • 0: Normal • Other than 0: Error (error code) 	—	System
(s1)+2	Own station channel	Specify the channel to be used by own station.	1, 2	User

Device	Item	Description	Setting range	Set by
(s1)+3	Target station CPU type	Specify the CPU type of the target station. <ul style="list-style-type: none"> • 0000H: Addressed to target station CPU (control CPU) • 03D0H: Addressed to control system CPU • 03D1H: Addressed to standby system CPU • 03D2H: Addressed to system A CPU • 03D3H: Addressed to system B CPU • 03E0H: Addressed to multiple CPU No. 1 • 03E1H: Addressed to multiple CPU No. 2 • 03E2H: Addressed to multiple CPU No. 3 • 03E3H: Addressed to multiple CPU No. 4 • 03FFH: Addressed to target station CPU (control CPU) 	0000H 03D0H to 03D3H 03E0H to 03E3H 03FFH	User
(s1)+4	Target network number	Specify the network number (1 to 239) of the target station.	1 to 239	User
(s1)+5	Target station number	Specify the station number of the target station. (1) Station number specification <ul style="list-style-type: none"> • 125: Master station • 126: Master operating station • 1 to 120: Local station, intelligent device station, submaster station (2) Group number specification <ul style="list-style-type: none"> • 0081H to 00A0H: All stations with group numbers 0001H to 0020H (Can be set when the execution type specified by (s1)+0 is "0: No arrival acknowledgment") (3) All-station specification <ul style="list-style-type: none"> • 00FFH: All stations of target network number (broadcast (excluding the own station)) (Can be set when the execution type specified by (s1)+0 is "0: No arrival acknowledgment") If the instruction is executed with group or all stations specification, specify "0000H" or "03FFH" for the target station's CPU type ((s1)+3).	Station No.: 1 to 120, 125, 126 Group number specification: 0081H to 00A0H All-station specification: 00FFH	User
(s1)+6	Not used	—	—	—
(s1)+7	Number of resends	Effective when the execution type specified by (s1)+0 is "1: Arrival acknowledgment used". ■Before instruction execution Specify the number of resends to be performed if the instruction is not completed within the monitoring time specified by (s1)+8. ■At completion of instruction The number of resends performed (result) is stored.	0 to 15	User/ system
(s1)+8	Arrival monitoring time	Effective when the execution type specified by (s1)+0 is "1: Arrival acknowledgment used". Specify the monitoring time until completion of processing. If processing is not completed within the monitoring time, the request is resent by the number of resends specified in (s1)+7. <ul style="list-style-type: none"> • 0: 10 seconds • 1 to 32767: 1 to 32767 seconds 	0 to 32767	User
(s1)+9	Write data length	Specify the number of words to be written. <ul style="list-style-type: none"> • 1 to 960 (words) (When writing data to QnACPU: 1 to 480 (words))	1 to 960	User
(s1)+10	Not used	—	—	—
(s1)+11	Clock setting flag	The validity status (valid or invalid) of the data in (s1)+12 and later is stored. Note that the data in (s1)+12 and later is not cleared even when the instruction is completed successfully. <ul style="list-style-type: none"> • 0: Invalid • 1: Valid 	—	System
(s1)+12	Clock data (Set only in an abnormal state)	Upper 8 bits: Month (01H to 12H) Lower 8 bits: Lower 2 digits of year (00H to 99H)	—	System
(s1)+13		Upper 8 bits: Hour (00H to 23H) Lower 8 bits: Day (01H to 31H)	—	System
(s1)+14		Upper 8 bits: Second (00H to 59H) Lower 8 bits: Minute (00H to 59H)	—	System
(s1)+15		Upper 8 bits: Upper 2 digits of the year (00H to 99H) Lower 8 bits: Day of the week (00H (Sun.) to 06H (Sat.))	—	System
(s1)+16		Error detection network number ^{*1}	The network number of the station in which an error was detected is stored. (No information is stored if an error is detected in the own station.) <ul style="list-style-type: none"> • 1 to 239 (Network number) 	—

Device	Item	Description	Setting range	Set by
(s1)+17	Error-detected station number*1	The station number of the station where an error was detected is stored. (No information is stored if an error is detected in the own station.) <ul style="list-style-type: none"> • 125: Master station • 1 to 120: Local station, intelligent device station, submaster station 	—	System

*1 If completion status ((s1)+1) is "Channel in use (dedicated instruction) (error codes: D25AH and D25BH)", data is not stored.

Point

- When a number from 1 to 120 is specified for the target station number, the GP.SWRITE instruction should be executed with the execution type set to "Arrival acknowledgment used" to improve data reliability. When a number from 81H to A0H or FFH is specified for the target station number, the GP.SWRITE instruction should be executed with the execution type set to "No arrival acknowledgment".
- When performing device writing to the same station from multiple stations, do not overlap the write timing. When the execution type is set to "No arrival acknowledgment", successful completion results in the write source station if communication is completed successfully even when the sending data contains an error. Also, even when the sending data is normal, a timeout results in the write source station if the GP.SWRITE instruction is executed for the same station from multiple stations.
- The number of resends (s1)+7 must be set every time the instruction is executed.

Processing details

- The instruction writes data by the specified number of words ((s1)+9) from the own station head device (s2) into the target station word devices. Specify the target stations in control data ((s1)+4) and ((s1)+5). Upon completion of writing device data to target station, the completion device specified by (d2) turns on. In the other station, upon completion of writing the device data specified by (s2), the device specified by (d3) turns on.
- For the target stations that can be specified, refer to the following.

☞ Page 44 Target networks and target station types

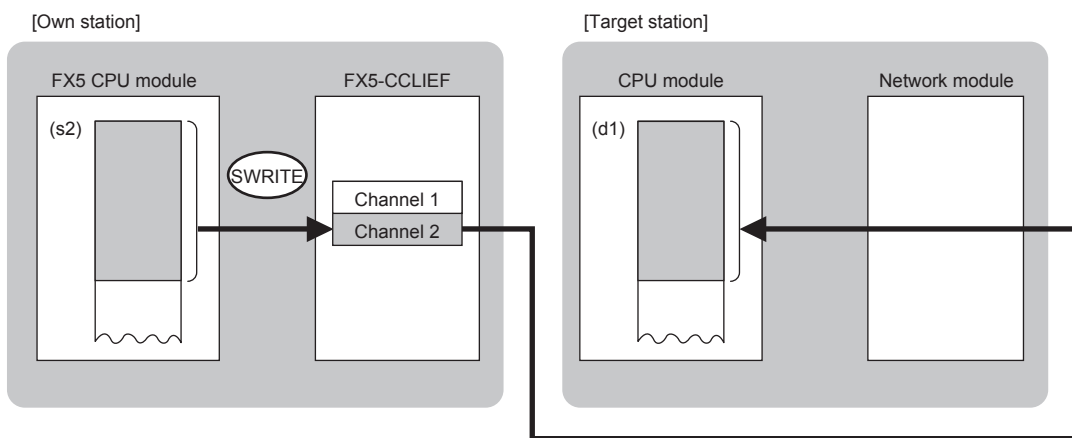

- When executing multiple link dedicated instructions concurrently, be careful not to overlap the channels of the link dedicated instructions. Multiple link dedicated instructions specifying the same channel cannot be used concurrently.
- The execution of the GP.SWRITE instruction and whether it has been completed normally or completed with an error can be checked with the completion device (d2) or completion status indication device (d2)+1.

Device	Operation
Completion device (d2)	The device turns on during the END processing for the scan in which the GP.SWRITE instruction is completed, and turns off during the next END processing.
Completion status indication device (d2)+1	The device turns on or off depending on the completion status of the GP.SWRITE instruction. When completed normally: The device does not change (remains off). When completed with an error: The device turns on during the END processing for the scan in which the GP.SWRITE instruction is completed, and turns off during the next END processing.

• The following figure shows the execution timing of the GP.SWRITE instruction.

■ When completed normally

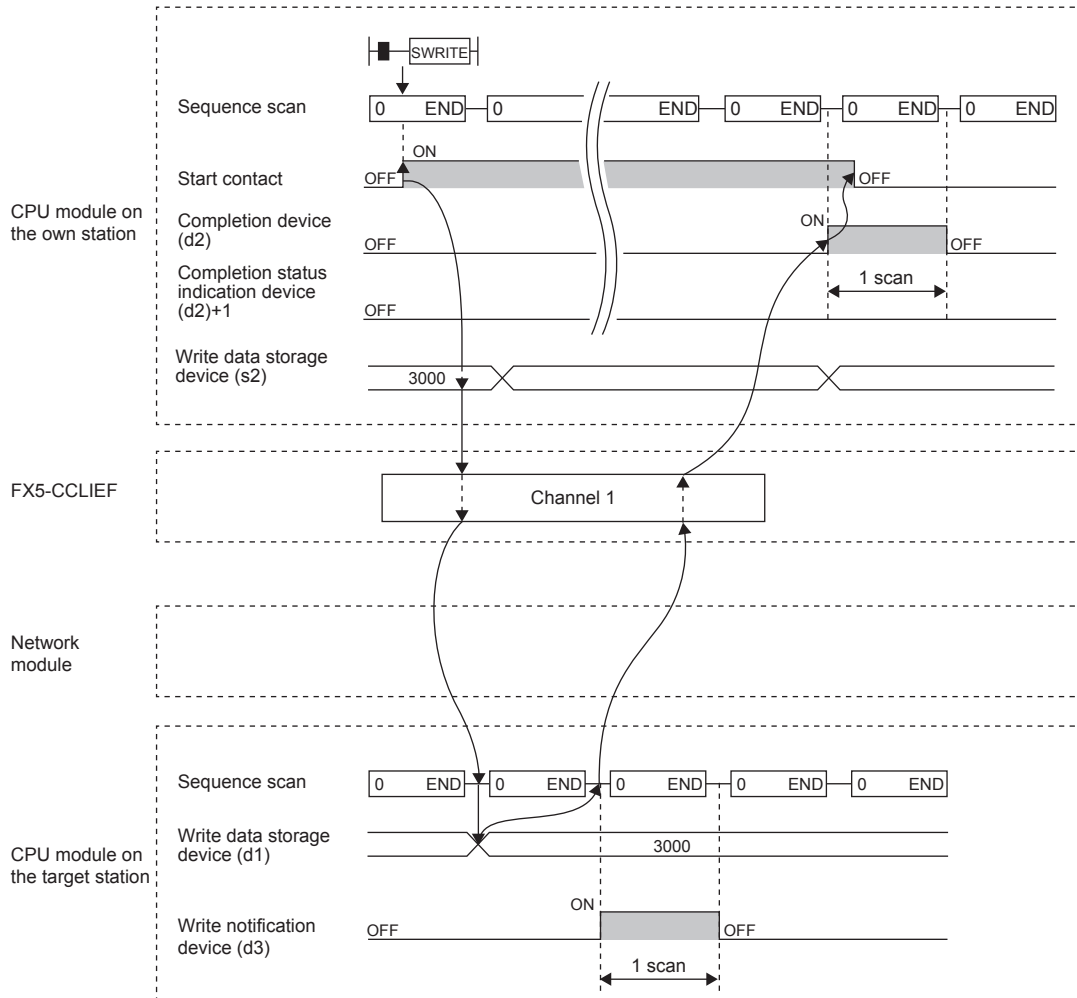

■ When completed with an error

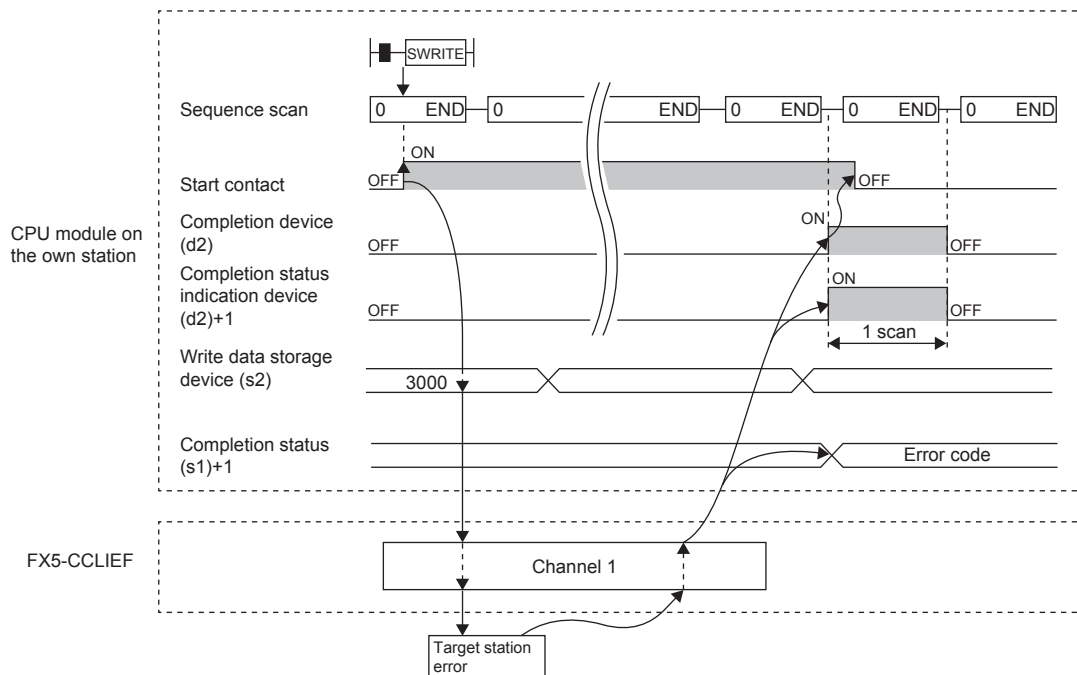

• Write processing is performed only once on the rising edge when the write command turns on.

Operation error

Error code ((s1)+1)	Description
D000H to DFFFH	Refer to  Page 120 List of Error Codes.

Program example

The following program is for writing data of D750 to D753 of station No. 2 (own station) into D300 to D303 of station No. 3 (target station) when M112 is turned on and for storing data of D300 to D303 into D500 to D503 when the write notification device (d3) is turned on in the target station.

- System configuration

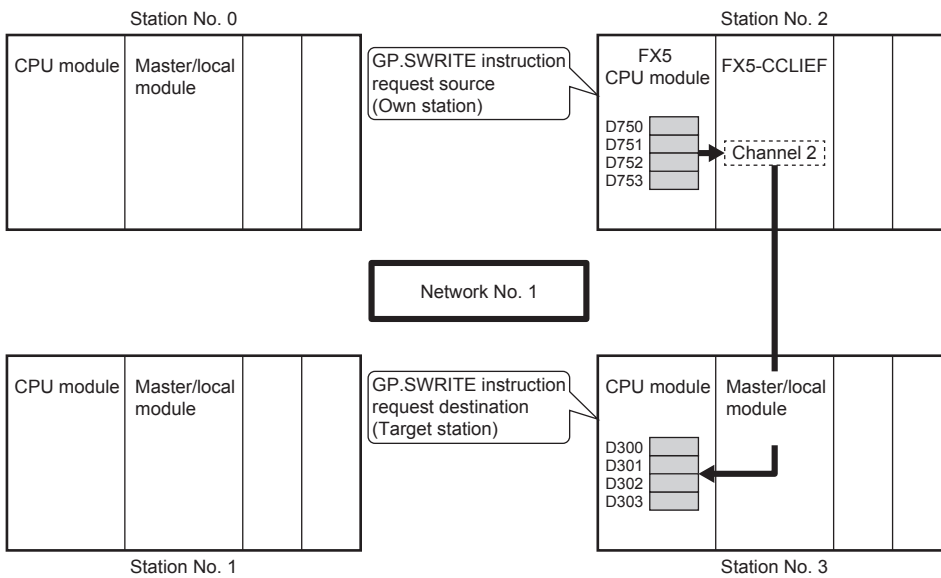

- Devices used

Device	Description
■Device used in the own station (station No. 2)	
SB0047	Baton pass status of own station
M110	Control data set command
M111	Write data setting command
M112	Start contact
M115	Completion device
M116	Completion status indication device
D220 to D237	Control data of the GP.SWRITE instruction (For the set value, refer to the following figure.)
D750 to D753	Write data storage device (station No. 2)
■Device used in the target station (station No. 3)	
M117	Write notification device used in the target station (station No. 3)
D500 to D503	Device for storing data of D300 to D303 used in the target station (station No. 3)

• Control data

Device	Item	Set value
(s1)+0	D220	Execution/error completion type 0081H • Arrival acknowledgment used • Set data for error completion.
(s1)+1	D221	Completion status Setting not required
(s1)+2	D222	Own station channel 2
(s1)+3	D223	Target station CPU type 0000H Addressed to target station CPU (control CPU)
(s1)+4	D224	Target network number 1
(s1)+5	D225	Target station number 3
(s1)+6	D226	Not used —
(s1)+7	D227	Number of resends 5 times
(s1)+8	D228	Arrival monitoring time 0 (10 seconds)
(s1)+9	D229	Write data length 4 words
(s1)+10	D230	Not used —
(s1)+11	D231	Clock set flag Setting not required
(s1)+12 to (s1)+15	D232 to D235	Clock data (Set only in an abnormal state)
(s1)+16	D236	Error detection network number
(s1)+17	D237	Error-detected station number

• Program

Write the following program to the FX5 CPU module of station No. 2.

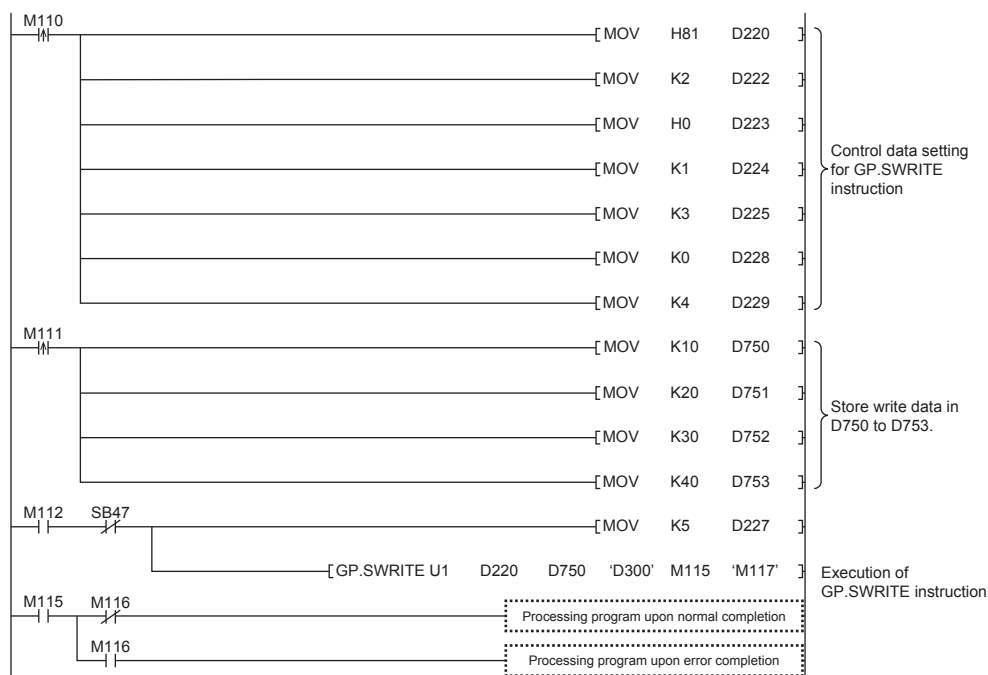

Write the following program to the CPU module of the target station of station No. 3.



Sending data to the programmable controller on another station

GP.SEND

This instruction sends data to another station programmable controller.

Ladder	ST
	<pre>ENO:=GP_SEND(EN,Un,s1,s2,d);</pre>

FBD/LD

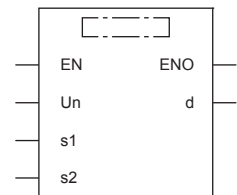

("GP_SEND" enters □.)

Setting data

■Description, range, data type

Operand	Description	Range	Data type	Data type (label)
(U) ^{*1}	Position number of the module connected	■FX5UJ CPU module 1H to 8H ■FX5U/FX5UC CPU module 1H to 10H	16-bit unsigned binary	ANY16
(s1)	Own station head device where control data is stored	Refer to Page 78 Control data.	Device name	ANY16 ^{*3}
(s2)	Own station head device where sending data is stored ^{*2}	—	Device name	ANY16 ^{*3}
(d)	Own station device to be turned on for one scan when the instruction completes. If the instruction is completed with an error, (d)+1 is also turned on.	—	Bit	ANYBIT_ARRAY (Number of elements: 2)
EN	Execution condition	—	Bit	BOOL
ENO	Execution result	—	Bit	BOOL

*1 In the case of the ST language and the FBD/LD language, U displays as Un.

*2 The continuous area specified by the send data length (s1)+9 is required.

*3 Digit specified bit type label cannot be used.

■Applicable devices

Operand	Bit	Word			Double word		Indirect specification	Constant			Others (U)
	X, Y, M, L, SM, F, B, SB, S	T, ST, C, D, W, SD, SW, R	U□\G□	Z	LC	LZ		K, H	E	\$	
(U)	—	○	—	—	—	—	○	○	—	—	○
(s1)	—	○	—	—	—	—	○	—	—	—	—
(s2)	—	○	—	—	—	—	○	—	—	—	—
(d)	○ ^{*1}	○ ^{*2}	—	—	—	—	—	—	—	—	—

*1 S cannot be used.

*2 T, ST, and C cannot be used.

Control data

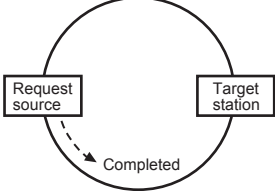
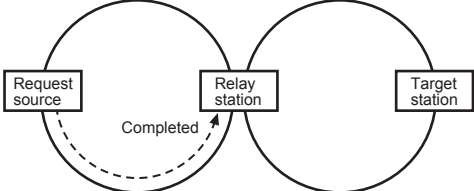
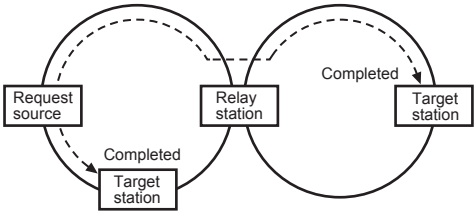
Device	Item	Description	Setting range	Set by				
(s1)+0	Execution/error completion type	<p>b15 ... b7 ... b0</p> <table border="1" style="margin-left: 20px;"> <tr> <td style="width: 20px;">0</td> <td style="width: 20px;">(2)</td> <td style="width: 20px;">0</td> <td style="width: 20px;">(1)</td> </tr> </table> <p>(1)? Execution type (bit 0)</p> <ul style="list-style-type: none"> • 0: No arrival acknowledgment <p>When the target station is in the same network: Completed when data has been sent from the own station.</p>  <p>When the target station is in another network: Completed when data has arrived the relay station of the own network.</p>  <ul style="list-style-type: none"> • 1: Arrival acknowledgment used <p>Completed when data has been stored in the specified channel of the target station.</p>  <p>(2) Error completion type (bit 7)</p> <p>Specify whether to set data at completion with an error.</p> <ul style="list-style-type: none"> • 0: Clock data at error occurrence is not stored in (s1)+11 and later. • 1: Clock data at error occurrence is stored in (s1)+11 and later. 	0	(2)	0	(1)	0000H 0001H 0080H 0081H	User
0	(2)	0	(1)					
(s1)+1	Completion status	The instruction completion status is stored.	—	System				
(s1)+2	Own station channel	Specify the channel to be used by own station.	1, 2	User				
(s1)+3	Target station storage channel	Specify the channel of the target station for storing data.	1 to 8	User				
(s1)+4	Target network number	Specify the network number of the target station.	1 to 239	User				
(s1)+5	Target station number	Specify the station number of the target station.	Station No.: 1 to 120, 125, 126 Group number specification: 0081H to 00A0H All-station specification: 00FFH	User				
(s1)+6	Not used	—	—	—				

Device	Item	Description	Setting range	Set by
(s1)+7	Number of resends (retries)	Effective when the execution type specified by (s1)+0 is "1: Arrival acknowledgment used". ■Before instruction execution Specify the number of resends to be performed if the instruction is not completed within the monitoring time specified by (s1)+8. ■At completion of instruction The number of resends performed (result) is stored.	0 to 15	User/ system
(s1)+8	Arrival monitoring time	Effective when the execution type specified by (s1)+0 is "1: Arrival acknowledgment used". Specify the monitoring time until completion of processing. If processing is not completed within the monitoring time, the request is resent by the number of resends specified in (s1)+7. • 0: 10 seconds • 1 to 32767: 1 to 32767 seconds	0 to 32767	User
(s1)+9	Send data length	Specify the number of sending data from (s2) to (s2)+n. • 1 to 960 (words) (When sending data to QnACPU: 1 to 480 (words))	1 to 960	User
(s1)+10	Not used	—	—	—
(s1)+11	Clock setting flag	The validity status (valid or invalid) of the data in (s1)+12 and later is stored. Note that the data in (s1)+12 and later is not cleared even when the instruction is completed successfully. • 0: Invalid • 1: Valid	—	System
(s1)+12	Clock data (Set only in an abnormal state)	Upper 8 bits: Month (01H to 12H) Lower 8 bits: Lower 2 digits of year (00H to 99H)	—	System
(s1)+13		Upper 8 bits: Hour (00H to 23H) Lower 8 bits: Day (01H to 31H)	—	System
(s1)+14		Upper 8 bits: Second (00H to 59H) Lower 8 bits: Minute (00H to 59H)	—	System
(s1)+15		Upper 8 bits: Upper 2 digits of the year (00H to 99H) Lower 8 bits: Day of the week (00H (Sun.) to 06H (Sat.))	—	System
(s1)+16		Error detection network number ^{*1}	The network number of the station in which an error was detected is stored. • 1 to 239 (Network number)	—
(s1)+17	Error-detected station number ^{*1}	The station number of the station where an error was detected is stored. • 125: Master station • 1 to 120: Local station, intelligent device station, submaster station	—	System

*1 If completion status ((s1)+1) is "Channel in use (dedicated instruction) (error codes: D25AH to D25BH)", data is not stored.

- When a number from 1 to 120 is specified for the target station number, the instruction should be executed with the execution type set to "Arrival acknowledgment used" to improve data reliability. When a group number or all stations are specified, the instruction should be executed with the execution type set to "No arrival acknowledgment".
- When sending data to the same channel in the receiving station, execute the instruction after data has been read by the GP.RECV instruction in the receiving station. When the execution type is set to "No arrival acknowledgment", successful completion results in the sending station if communication is completed successfully even when the sending data contains an error. Also, even when the sending data is normal, a timeout results in the sending station if the instructions are executed for the same station from multiple stations.
- With the execution type set to "Arrival acknowledgment used", if the sending station sends data to the same channel in the receiving station before the receiving station reads data using the GP.RECV instruction, a buffer full error results in the sending station.

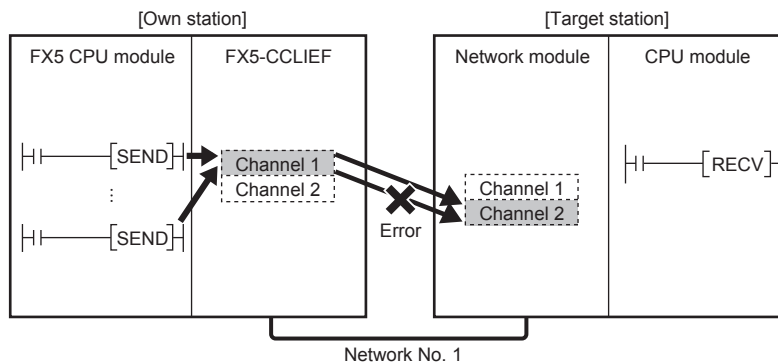

- When multiple network modules are mounted in the target station, specify the network number and station number of the network module that receives a request from the own station.
(Example: In the following figure, specify station No. 1 of network No. 1. (Station No. 5 of network No. 2. cannot be specified.))

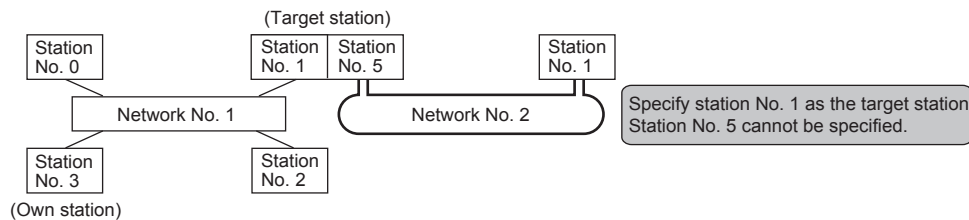

- The number of resends (s1)+7 must be set every time the instruction is executed.

Processing details

- The instruction sends data by the specified number of words ((s1)+9) from the own station head device (s2) into the specified channel of a target station. The data that has been sent is stored in the channel specified by (s2) in the target station. To read the sent data in the target station, use the GP.RECV instruction. Upon completion of sending data to the target station number, the completion device specified by (d) turns on.
- For the target stations that can be specified, refer to the following.

☞ Page 44 Target networks and target station types

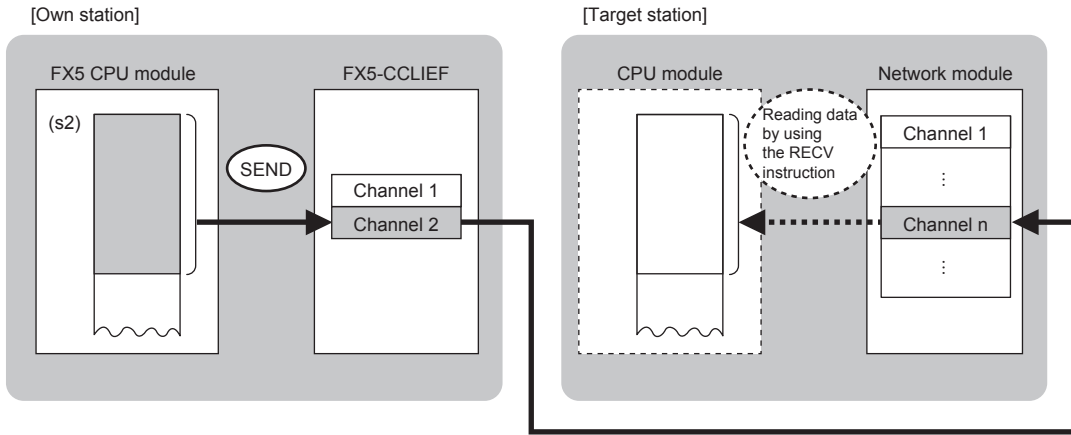

- Data can be sent not only to the stations connected to the own station network but also to stations connected to the specified network number of MELSECNET/H, MELSECNET/10, or Ethernet.
- When executing multiple link dedicated instructions concurrently, be careful not to overlap the channels of the link dedicated instructions. Multiple link dedicated instructions specifying the same channel cannot be used concurrently.
- The execution of the GP.SEND instruction and whether it has been completed normally or completed with an error can be checked with the completion device (d) or completion status indication device (d)+1.

Device	Operation
Completion device (d)	The device turns on during the END processing for the scan in which the GP.SEND instruction is completed, and turns off during the next END processing.
Completion status indication device (d)+1	The device turns on or off depending on the completion status of the GP.SEND instruction. When completed normally: The device does not change (remains off). When completed with an error: The device turns on during the END processing for the scan in which the GP.SEND instruction is completed, and turns off during the next END processing.

• The following figure shows the execution timing of the SEND instruction.

■ When completed normally

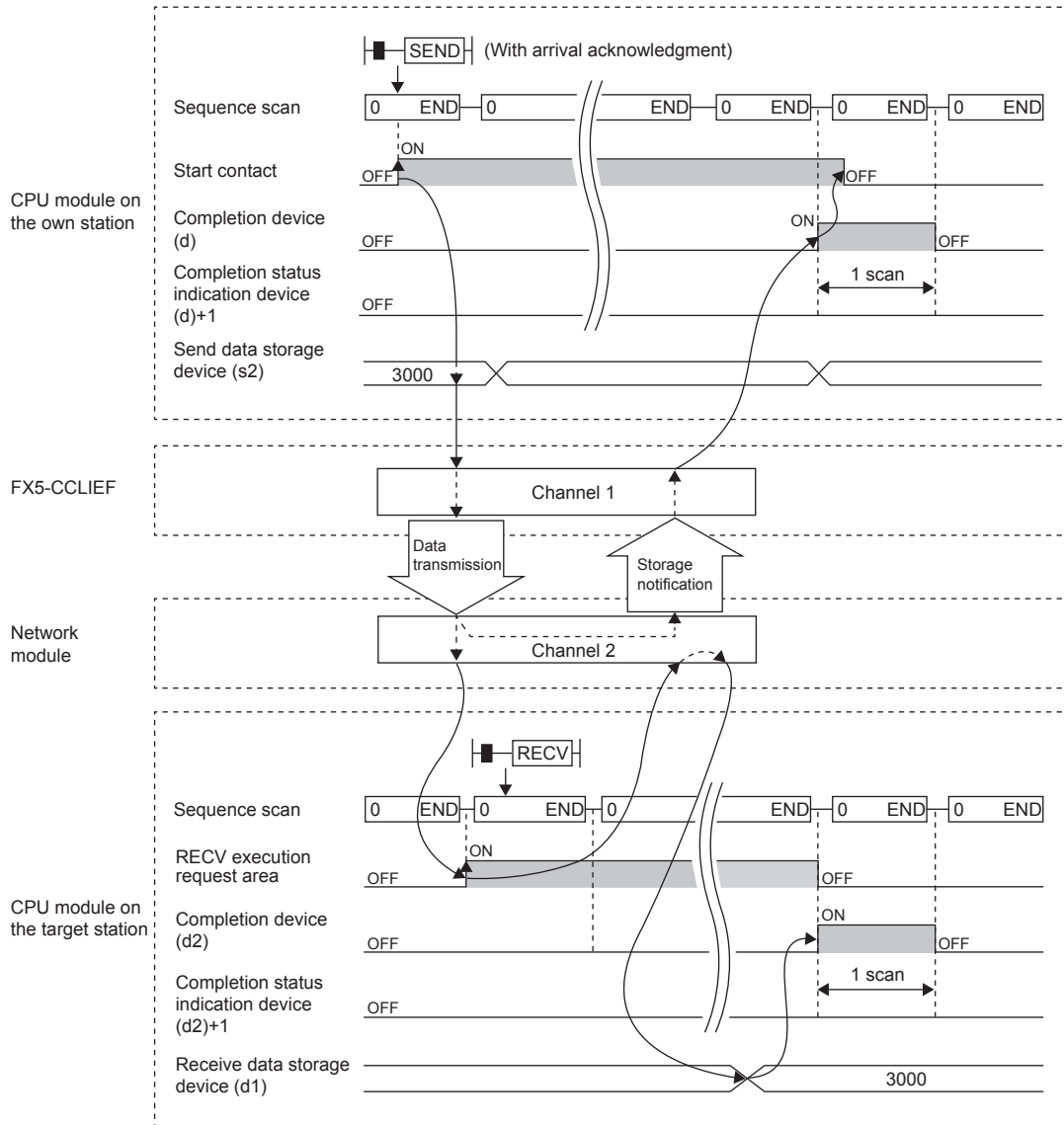

■ When completed with an error

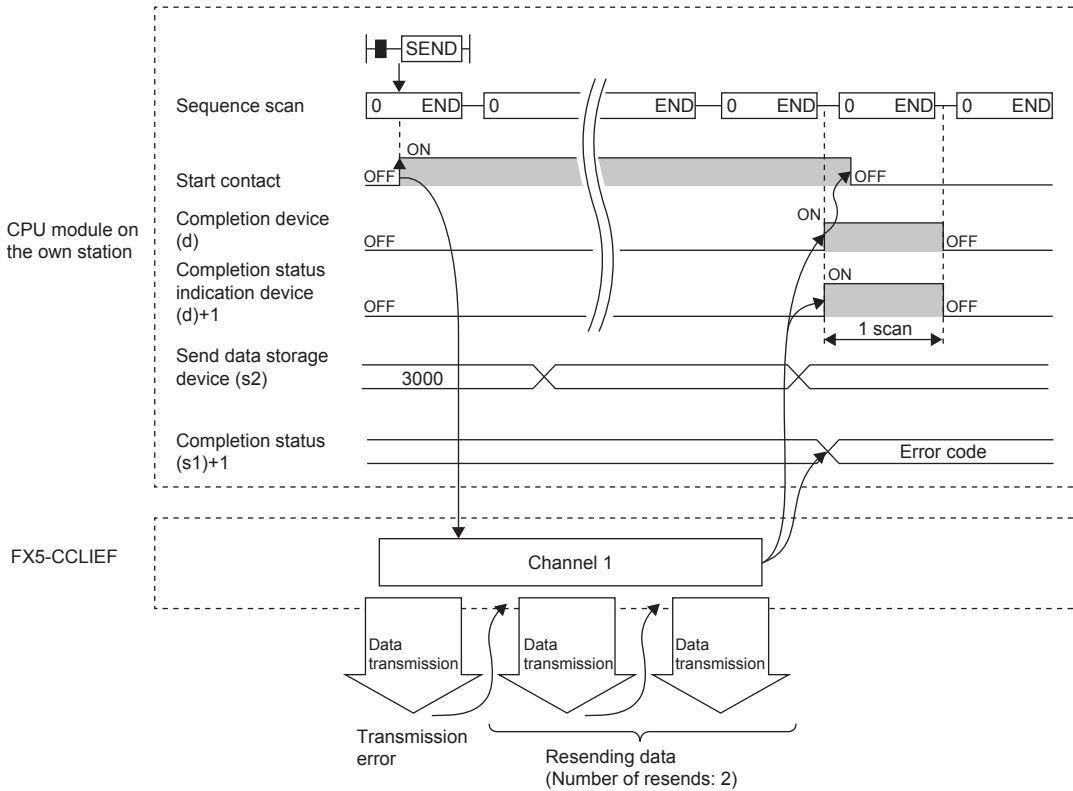

- Send processing is performed only once on the rising edge when the send command turns on.

Operation error

Error code ((s1)+1)	Description
D000H to DFFFH	Refer to Page 120 List of Error Codes.

Program example

The following program is for sending data of D750 to D753 of station No. 1 (own station) into channel 2 of station No. 2 (target station) when M152 is turned on.

- System configuration

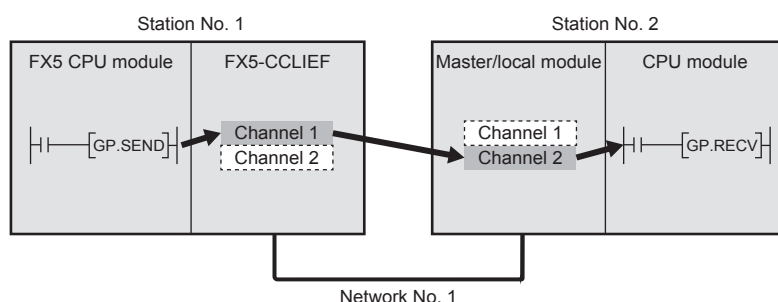

- Devices used

Device	Description
SB0047	Baton pass status of own station
M150	Control data set command
M151	Send data setting command
M152	Start contact
M155	Completion device
M156	Completion status indication device
D350 to D367	Control data of the GP.SEND instruction (For the set value, refer to the following figure.)
D750 to D753	Send data storage device (station No. 1)

- Control data

Device	Item	Set value
(s1)+0	D350	Execution/error completion type 0081H • Arrival acknowledgment used • Set data for error completion.
(s1)+1	D351	Completion status Setting not required
(s1)+2	D352	Own station channel 1
(s1)+3	D353	Target station storage channel 2
(s1)+4	D354	Target network number 1
(s1)+5	D355	Target station number 2
(s1)+6	D356	Not used —
(s1)+7	D357	Number of resends 5 times
(s1)+8	D358	Arrival monitoring time 0 (10 seconds)
(s1)+9	D359	Send data length 4 words
(s1)+10	D360	Not used —
(s1)+11	D361	Clock set flag Setting not required
(s1)+12 to (s1)+15	D362 to D365	Clock data (Set only in an abnormal state)
(s1)+16	D366	Error detection network number
(s1)+17	D367	Error-detected station number

■Program using module FB

Program as follows when using the module FB

- Devices used

Device	Description
SB0047	Baton pass status of own station
M150	Setting command of module FB
M151	Send data setting command
M152	Execution command of module FB
M154 to M156	Bit-type input output label for module FB (Refer to the following table for the setting.)
D352 to D355, D359 and D368	Word-type input output label for module FB (Refer to the following table for the setting.)
D750 to D753	Send data storage device (station No. 1)

- Instance name of module FB

Name of module FB	Instance name
M+FX5CCLIEF_Send	Send

- FX5-CCLIEF module label

Module label name	Module No.
FX5CCLIEF_1	No.1

- Label to be used

Label name	Item	Setting value/setting device
■Input label		
i_bEN	Execution command	—
i_stModule	Module label	FX5CCLIEF_1
i_uTargetNetworkNo	Target network number	1 (D354)
i_uTargetStationNo	Target station number	2 (D355)
i_uChannel	Own station channel	1 (D352)
i_uTargetChannel	Target station data storage channel	2 (D353)
i_uDataLength	Send data length	4 words (D359)
i_uSendData	Send Data Storage Device	D750
■Output label		
o_bENO	Execution status	M154
o_bOK	Normal completion	M155
o_bErr	Abnormal end	M156
o_uErrId	Error code	D368
■Public label		
pbi_uMonitorTime	Arrival monitoring time	0 (10 seconds)

• Program

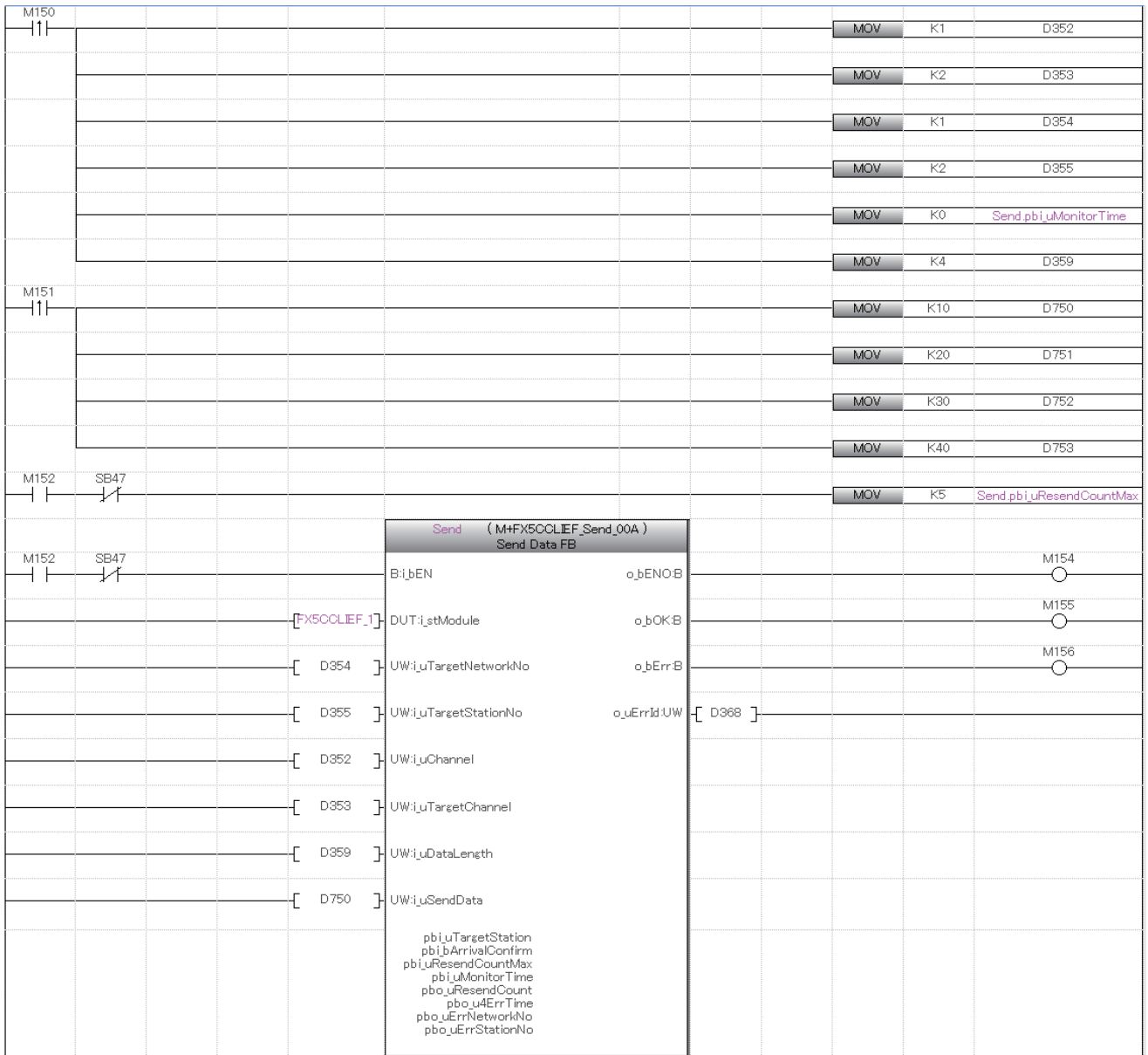

Add the processing program when completed successfully and completed with an error after the program above.

Receiving data from the programmable controller on another station

GP.RECV

This instruction reads data received from another station programmable controller. (For the main routine program)

Ladder	ST
	<pre>ENO:=GP_RECV(EN,Un,s,d1,d2);</pre>

FBD/LD

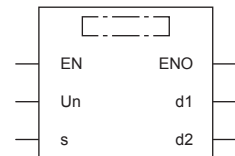

("GP_RECV" enters □.)

Setting data

■Description, range, data type

Operand	Description	Range	Data type	Data type (label)
(U) ^{*1}	Position number of the module connected	<ul style="list-style-type: none"> ■FX5UJ CPU module 1H to 8H ■FX5U/FX5UC CPU module 1H to 10H 	16-bit unsigned binary	ANY16
(s)	Own station head device where control data is stored	Refer to Page 89 Control data.	Device name	ANY16 ^{*3}
(d1)	Own station head device for storing the receive data ^{*2}	—	Device name	ANY16 ^{*3}
(d2)	Own station device to be turned on for one scan when the instruction completes. (d2)+1 also turns on when the instruction completes with an error.	—	Bit	ANYBIT_ARRAY (Number of elements: 2)
EN	Execution condition	—	Bit	BOOL
ENO	Execution result	—	Bit	BOOL

*1 In the case of the ST language and the FBD/LD language, U displays as Un.

*2 The continuous area (a maximum of 960 words) specified by the receive data length (s)+9 is required.

*3 Digit specified bit type label cannot be used.

■Applicable devices

Operand	Bit	Word			Double word		Indirect specification	Constant			Others (U)
	X, Y, M, L, SM, F, B, SB, S	T, ST, C, D, W, SD, SW, R	U□\G□	Z	LC	LZ		K, H	E	\$	
(U)	—	○	—	—	—	—	○	○	—	—	○
(s)	—	○	—	—	—	—	○	—	—	—	—
(d1)	—	○	—	—	—	—	○	—	—	—	—
(d2)	○ ^{*1}	○ ^{*2}	—	—	—	—	—	—	—	—	—

*1 S cannot be used.

*2 T, ST, and C cannot be used.

Control data

Device	Item	Description	Setting range	Set by			
(s)+0	Error completion type	b15 ... b7 ... b0 <table border="1" style="margin-left: 40px;"> <tr> <td style="width: 40px; text-align: center;">0</td> <td style="width: 10px; text-align: center;">(1)</td> <td style="width: 40px; text-align: center;">0</td> </tr> </table> (1) Error completion type (bit 7) Specify whether to set data at completion with an error. • 0: Clock data at error occurrence is not stored in (s1)+11 and later. • 1: Clock data at error occurrence is stored in (s1)+11 and later.	0	(1)	0	0000H 0080H	User
0	(1)	0					
(s)+1	Completion status	The instruction completion status is stored. • 0: Normal • Other than 0: Error (error code)	—	System			
(s)+2	Own station storage channel	Specify the channel to be used by own station.	1, 2	User			
(s)+3	Channel used by send station	The channel number (1 to 8) used by the sending station is stored.	—	System			
(s)+4	Sending station network number	The network number (1 to 239) of the sending station is stored.	—	System			
(s)+5	Sending-station No.	The station number of the sending station is stored. • 125: Master station, submaster station (operating as master station) • 1 to 120: Local station, intelligent device station, submaster station (operating as slave)	—	System			
(s)+6	Not used	—	—	—			
(s)+7	Not used	—	—	—			
(s)+8	Arrival monitoring time	Specify the monitoring time until completion of processing. The instruction is completed with an error if it fails to complete within the monitoring time. • 0: 10 seconds • 1 to 32767: 1 to 32767 seconds	0 to 32767	User			
(s)+9	Receive data length	The number of data received and stored in (d1) to (d1)+n is stored. • 0: No receive data • 1 to 960: Number of words of received data	—	System			
(s)+10	Not used	—	—	—			
(s)+11	Clock setting flag	The validity status (valid or invalid) of the data in (s)+12 and later is stored. Note that the data in (s)+12 and later is not cleared even when the instruction is completed successfully. • 0: Invalid • 1: Valid	—	System			
(s)+12	Clock data (Set only in an abnormal state)	Upper 8 bits: Month (01H to 12H) Lower 8 bits: Lower 2 digits of year (00H to 99H)	—	System			
(s)+13		Upper 8 bits: Hour (00H to 23H) Lower 8 bits: Day (01H to 31H)	—	System			
(s)+14		Upper 8 bits: Second (00H to 59H) Lower 8 bits: Minute (00H to 59H)	—	System			
(s)+15		Upper 8 bits: Upper 2 digits of the year (00H to 99H) Lower 8 bits: Day of the week (00H (Sun.) to 06H (Sat.))	—	System			
(s)+16		Error detection network number ^{*1}	The network number of the station in which an error was detected is stored. • 1 to 239 (Network number)	—	System		
(s)+17	Error-detected station number ^{*1}	The station number of the station where an error was detected is stored. • 125: Master station • 1 to 120: Local station, intelligent device station, submaster station	—	System			

*1 If completion status ((s1)+1) is "Channel in use (dedicated instruction) (error codes: D25AH to D25BH)", data is not stored.

Processing details

- This instruction reads data, which were sent from another station by the SEND instruction, from the specified channel of the own station to the own station word device (after (d1)). When the data reading from the specified channel of the own station is completed, the completion device (d2) turns on.
- For the target stations that can be specified, refer to the following.

☞ Page 44 Target networks and target station types

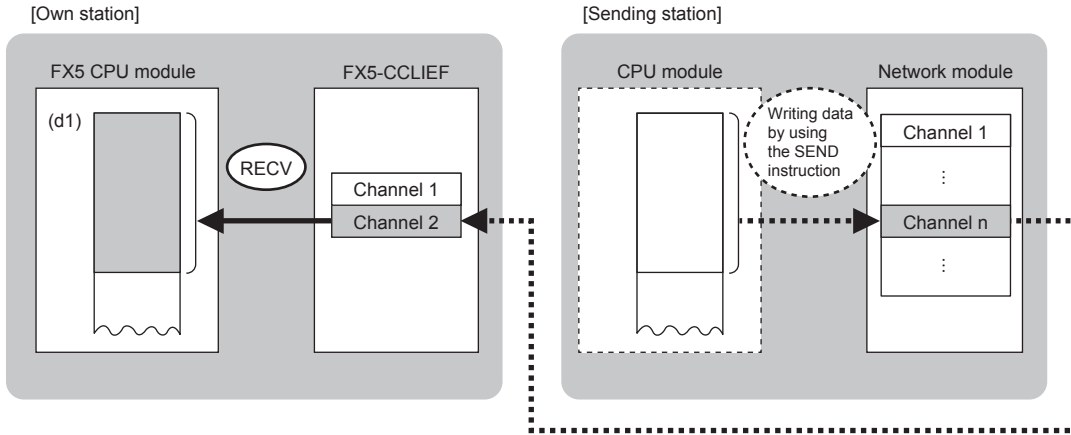

- The data received from the sending station is stored in the own station channel specified by the sending station and the corresponding bit in the GP.RECV instruction execution request area corresponding to each channel is set to on. When the corresponding bit in the GP.RECV instruction execution request area is set to on, the received data is read from the receive data storage channel. The following table lists the GP.RECV instruction execution request areas.

Name of GP.RECV instruction execution request area	Device number/address of corresponding bit
GP.RECV execution request flag Channel 1	SB0030
GP.RECV execution request flag Channel 2	SB0031

- When executing multiple link dedicated instructions concurrently, be careful not to overlap the channels of the link dedicated instructions. Multiple link dedicated instructions specifying the same channel cannot be used concurrently.
- The execution of the GP.RECV instruction and whether it has been completed normally or completed with an error can be checked with the completion device (d2) or completion status indication device (d2)+1.

Device	Operation
Completion device (d2)	The device turns on during the END processing for the scan in which the GP.RECV instruction is completed, and turns off during the next END processing.
Completion status indication device (d2)+1	The device turns on or off depending on the completion status of the GP.RECV instruction. When completed normally: The device does not change (remains off). When completed with an error: The device turns on during the END processing for the scan in which the GP.RECV instruction is completed, and turns off during the next END processing.

• The following figure shows the execution timing of the GP.RECV instruction.

■ When completed normally

For the execution timing, refer to the following instruction.

(☞ Page 77 GP.SEND)

■ When completed with an error

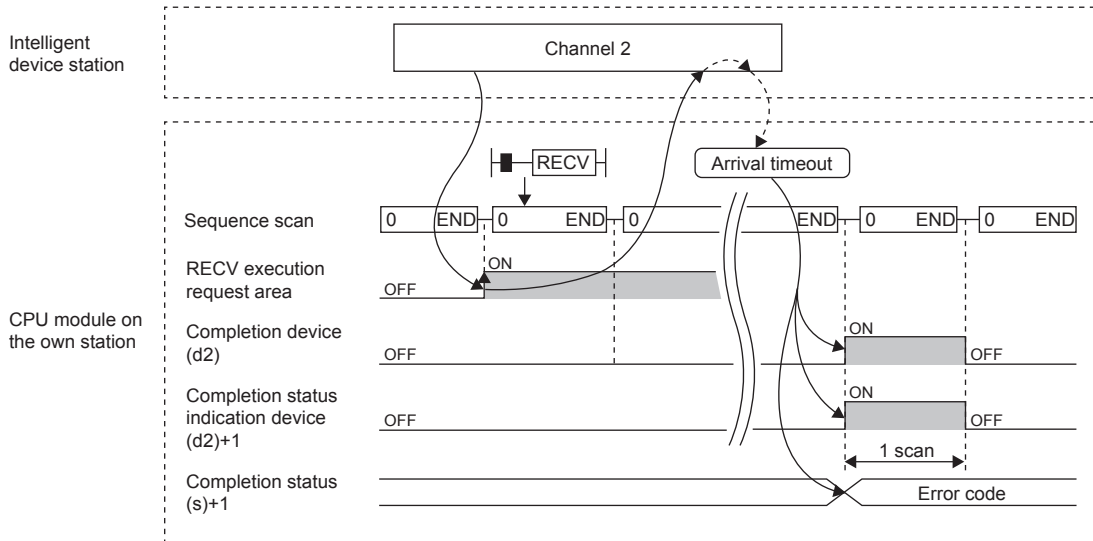

• Read processing is performed only once on the rising edge when the read command turns on.

Operation error

Error code ((s)+1)	Description
D000H to DFFFH	Refer to ☞ Page 120 List of Error Codes.

Program example

The following program is for reading the data sent from station No. 1 (another station) by the SEND instruction, from channel 2 of station No. 2 (own station) to D770 to D773, when SB0031 is turned on.

- System configuration

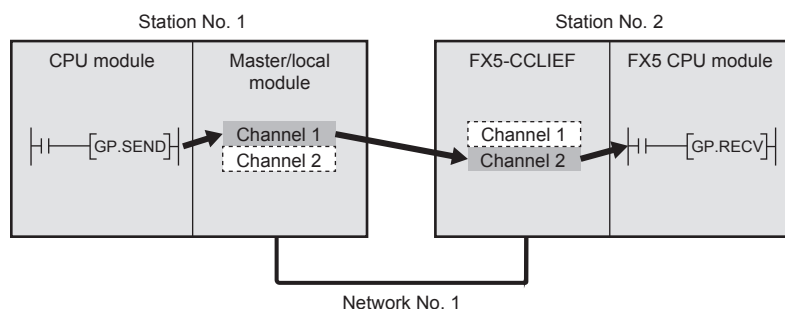

- Devices used

Device	Description
SB0031	GP.RECV execution request flag CH2
M165	Completion device
M166	Completion status indication device
D370 to D387	Control data of the GP.RECV instruction (For the set value, refer to the following figure.)
D770 to D773	Receive data storage device

- Control data

Device	Item	Set value
(s)+0	D370	Error completion type 0080H Set data for error completion.
(s)+1	D371	Completion status Setting not required
(s)+2	D372	Own station storage channel 2
(s)+3	D373	Channel used by sending station Setting not required
(s)+4	D374	Sending station network number
(s)+5	D375	Sending station number
(s)+6	D376	Not used —
(s)+7	D377	Not used —
(s)+8	D378	Arrival monitoring time 0 (10 seconds)
(s)+9	D379	Receive data length Setting not required
(s)+10	D380	Not used —
(s)+11	D381	Clock set flag Setting not required
(s)+12 to (s)+15	D382 to D385	Clock data (Set only in an abnormal state)
(s)+16	D386	Error detection network number
(s)+17	D387	Error-detected station number

- Program

Write the following program to the FX5 CPU module of station No. 2.

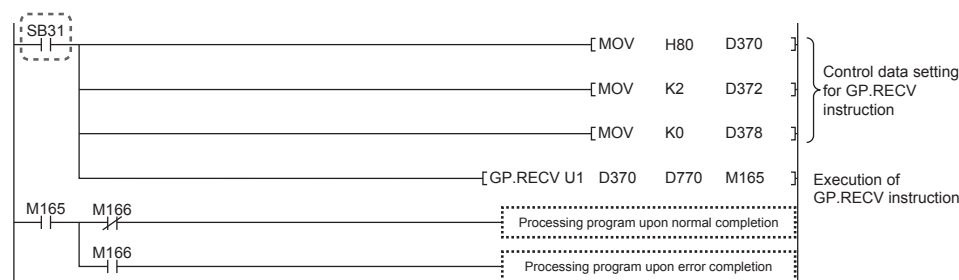

■ Program using module FB

Program as follows when using the module FB

- Devices used

Device	Description
SB0031	GP.RECV execution request flag CH2
M164 to M166	Bit-type input output label for module FB (Refer to the following table for the setting.)
D372, D379 and D388	Word-type input output label for module FB (Refer to the following table for the setting.)
D770 to D773	Receive data storage device

- Instance name of module FB

Name of module FB	Instance name
M+FX5CCLIEF_Recv	Recv

- FX5-CCLIEF module label

Module label name	Module No.
FX5CCLIEF_1	No.1

- Label to be used

Label name	Item	Setting value/setting device
■Input label		
i_bEN	Execution command	—
i_stModule	Module label	FX5CCLIEF_1
i_uRecvChannel	Receive data storage channel	2 (D372)
■Output label		
o_bENO	Execution status	M164
o_bOK	Normal completion	M165
o_bErr	Abnormal end	M166
o_uErrId	Error code	D388
o_uRecvDataLength	Receive data length	D379
o_uRecvData	Receive Data Storage Device	D770
■Public label		
pbi_uMonitorTime	Arrival monitoring time	0 (10 seconds)

- Program

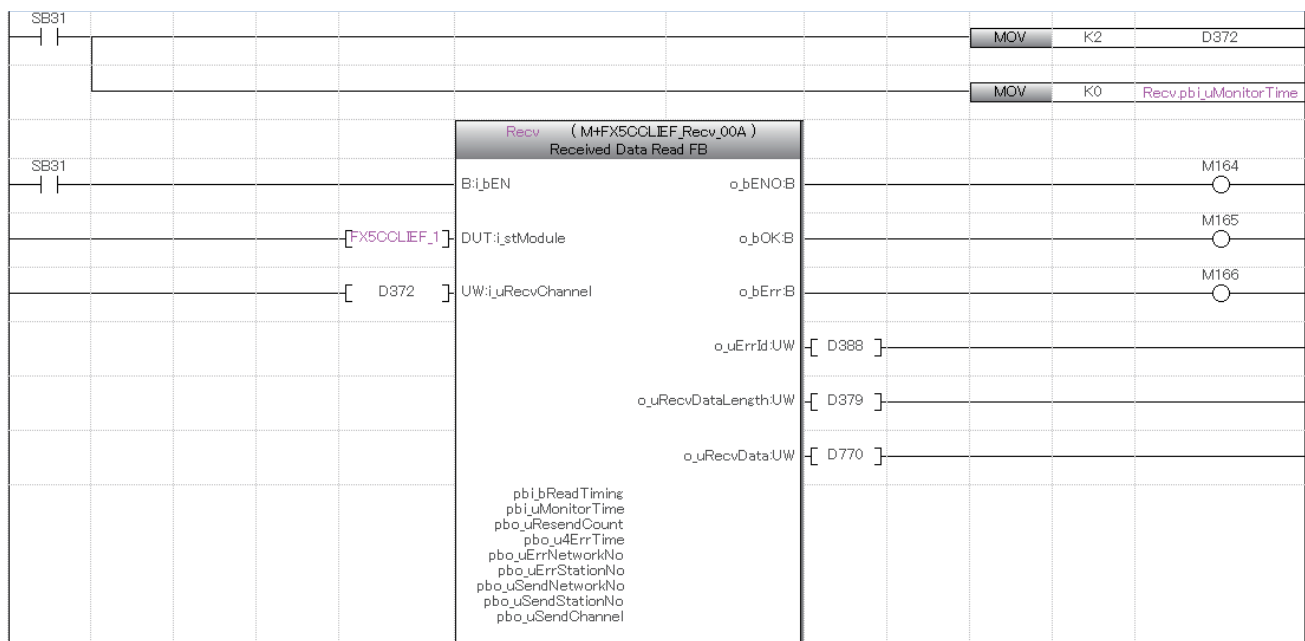

Add the processing program when completed successfully and completed with an error after the program above.

8.3 Other Instructions

Setting parameters

G(P).CCPASET

Set the parameters to the FX5-CCLIEF.

Ladder	ST
	<pre>ENO:=G_CCPASET(EN,Un,s1,s2,s3,s4,d); ENO:=GP_CCPASET(EN,Un,s1,s2,s3,s4,d);</pre>

FBD/LD

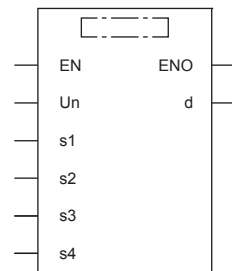

("G_CCPASET", "GP_CCPASET" enters □.)

Setting data

■Description, range, data type

Operand	Description	Range	Data type	Data type (label)
(U) ^{*1}	Position number of the module connected	<ul style="list-style-type: none"> ■FX5UJ CPU module 1H to 8H ■FX5U/FX5UC CPU module 1H to 10H 	16-bit unsigned binary	ANY16
(s1)	Own station head device where control data is stored	Refer to Page 95 Control data.	Device name	ANY16 ^{*3}
(s2)	Dummy device ^{*2}	—	Device name	ANY16 ^{*3}
(s3)	Dummy device ^{*2}	—	Device name	ANY16 ^{*3}
(s4)	Dummy device ^{*2}	—	Device name	ANY16 ^{*3}
(d)	Own station device to be turned on for one scan when the instruction completes. If the instruction is completed with an error, (d)+1 is also turned on.	—	Bit	ANYBIT_ARRAY (Number of elements: 2)
EN	Execution condition	—	Bit	BOOL
ENO	Execution result	—	Bit	BOOL

*1 In the case of the ST language and the FBD/LD language, U displays as Un.

*2 Since the operands (s2) to (s4) are not used for the FX5-CCLIEF, specify dummy devices.

*3 Digit specified bit type label cannot be used.

■Applicable devices

Operand	Bit	Word			Double word		Indirect specification	Constant			Others (U)
	X, Y, M, L, SM, F, B, SB, S	T, ST, C, D, W, SD, SW, R	U□\G□	Z	LC	LZ		K, H	E	\$	
(U)	—	○	—	—	—	—	○	○	—	—	○
(s1)	—	○	—	—	—	—	○	—	—	—	—
(s2)	—	○	—	—	—	—	○	—	—	—	—
(s3)	—	○	—	—	—	—	○	—	—	—	—
(s4)	—	○	—	—	—	—	○	—	—	—	—
(d)	○*1	○*2	—	—	—	—	—	—	—	—	—

*1 S cannot be used.

*2 T, ST, and C cannot be used.

■Control data

Device	Item	Description	Setting range	Set by						
(s1)+0	Completion status	The instruction completion status is stored. • 0: Normal • Other than 0: Error (error code)	—	System						
(s1)+1	Setting flag	b15 ... b13 b12 b11 b10 b9 b8 b7 ... b0 <table border="1" style="margin-left: 20px;"> <tr> <td style="width: 20px;">0</td> <td style="width: 20px;">(3)</td> <td style="width: 20px;">0</td> <td style="width: 20px;">(2)</td> <td style="width: 20px;">(1)</td> <td style="width: 20px;">0</td> </tr> </table> (1) Input setting for data link error (bit 8) • 0: Cleared • 1: Held (2) Output setting for CPU STOP (bit 9) • 0: Held • 1: Cleared (3) Output setting for CPU error (bit 12) • 0: Cleared • 1: Held	0	(3)	0	(2)	(1)	0	Shown on left side	User
0	(3)	0	(2)	(1)	0					

Processing details

- Set the parameters to the FX5-CCLIEF.

[Own station]

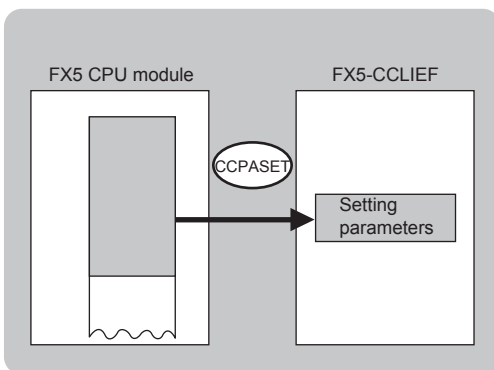

- The execution of the G(P).CCPASET instruction and whether it has been completed normally or completed with an error can be checked with the completion device (d) or completion status indication device (d)+1.

Device	Operation
Completion device (d)	The device turns on during the END processing for the scan in which the G(P).CCPASET instruction is completed, and turns off during the next END processing.
Completion status indication device (d)+1	The device turns on or off depending on the completion status of the G(P).CCPASET instruction. When completed normally: The device does not change (remains off). When completed with an error: The device turns on during the END processing for the scan in which the G(P).CCPASET instruction is completed, and turns off during the next END processing.

• The following figure shows the operation at completion of the G(P).CCPASET instruction.

■ When completed normally

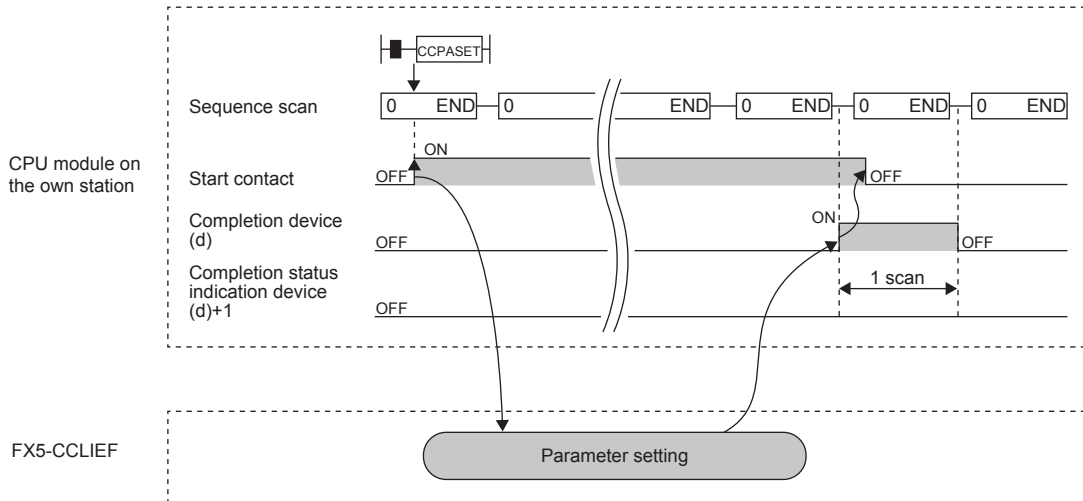

■ When completed with an error

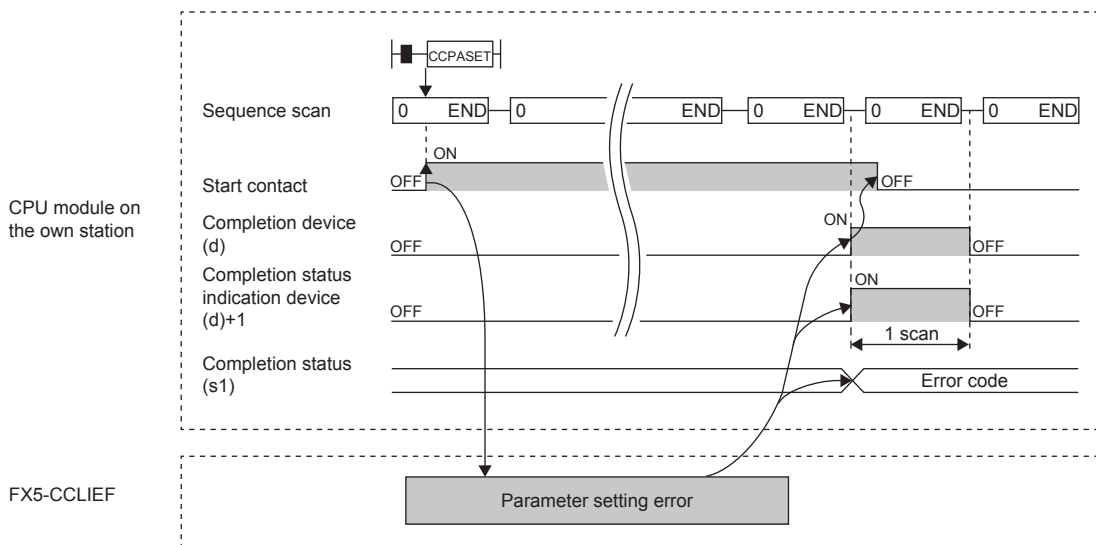

Operation error

Error code ((s1)+0)	Description
D000H to DFFFH	Refer to Page 120 List of Error Codes.

■ Program using module FB

Program as follows when using the module FB

- Devices used

Device	Description
M181	Baton pass status of own station
M184 to M186	Bit-type input output label for module FB (Refer to the following table for the setting.)
D2741	Word-type input output label for module FB (Refer to the following table for the setting.)
D2710, D2720, D2730 and D2740	Dummy device

- Instance name of module FB

Name of module FB	Instance name
M+FX5CCLIEF_SetParameter	SetParameter

- FX5-CCLIEF module label

Module label name	Module No.
FX5CCLIEF_1	No.1

- Label to be used

Label name	Item	Setting value/setting device
■ Input label		
i_bEN	Execution command	—
i_stModule	Module label	FX5CCLIEF_1
i_uTotalStations	Total number of slave stations	—
i_u605NetworkConfigurationSet	Network configuration setting data	—
i_u8ReservedStationSet	Reserved station setting data	—
i_u8ErrInvalidStationSet	Error invalid station setting data	—
■ Output label		
o_bENO	Execution status	M184
o_bOK	Normal completion	M185
o_bErr	Abnormal end	M186
o_uErrId	Error code	D2741
■ Public label		
pbi_bCPU_StopOutputSet	CPU STOP output setting	On

- Program

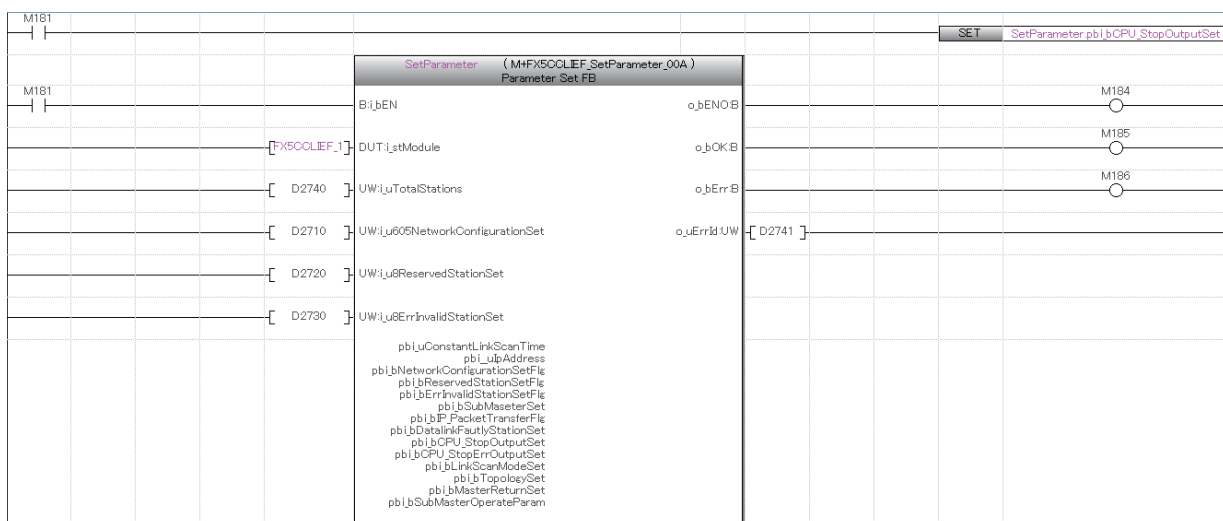

Add the processing program when completed successfully and completed with an error after the program above.

Operating procedure

The procedure of parameter settings using the G(P).CCPASET instruction is as follows.

- 1.** Before setting parameters using the G(P).CCPASET instruction, set the following item in the network parameters of GX Works3.
 - Network Number: Set the desired value.
 - Setting Method: Set the desired value.
 - Parameter Setting Method: Select "Program".
- 2.** Create a G(P).CCPASET instruction program.
- 3.** Write parameters and programs to the FX5 CPU module through GX Works3.
- 4.** Execute the G(P).CCPASET instruction.

Setting the station number to own station

G(P).UINI

This instruction sets the station number to the intelligent device station (own station) whose station number has not yet been set.

Ladder	ST
	<pre>ENO:=G_UINI(EN,Un,s,d); ENO:=GP_UINI(EN,Un,s,d);</pre>

FBD/LD

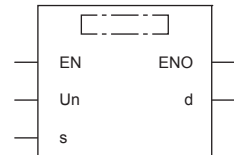

("G_UINI", "GP_UINI" enters □.)

Setting data

■Description, range, data type

Operand	Description	Range	Data type	Data type (label)
(U) ^{*1}	Position number of the module connected	<ul style="list-style-type: none"> ■FX5UJ CPU module 1H to 8H ■FX5U/FX5UC CPU module 1H to 10H 	16-bit unsigned binary	ANY16
(s)	Own station head device where control data is stored	Refer to Page 101 Control data.	Device name	ANY16 ^{*2}
(d)	Own station device to be turned on for one scan when the instruction completes. If the instruction is completed with an error, (d)+1 is also turned on.	—	Bit	ANYBIT_ARRAY (Number of elements: 2)
EN	Execution condition	—	Bit	BOOL
ENO	Execution result	—	Bit	BOOL

*1 In the case of the ST language and the FBD/LD language, U displays as Un.

*2 Digit specified bit type label cannot be used.

■Applicable devices

Operand	Bit	Word			Double word		Indirect specification	Constant			Others (U)
	X, Y, M, L, SM, F, B, SB, S	T, ST, C, D, W, SD, SW, R	U□\G□	Z	LC	LZ		K, H	E	\$	
(U)	—	○	—	—	—	—	○	○	—	—	○
(s)	—	○	—	—	—	—	○	—	—	—	—
(d)	○ ^{*1}	○ ^{*2}	—	—	—	—	—	—	—	—	—

*1 S cannot be used.

*2 T, ST, and C cannot be used.

Control data

Device	Item	Description	Setting range	Set by
(s)+0	—	Not used	—	System
(s)+1	Completion status	The instruction completion status is stored. • 0: Normal • Other than 0: Error (error code)	—	System
(s)+2	Change target specification	0001H (fixed)	0001H	User
(s)+3	Station number of own station	Specifies the station number to be set.	1 to 120	User
(s)+4 to (s)+9	—	Not used	—	System

Processing details

- Set the station number to the intelligent device station.

[Own station]

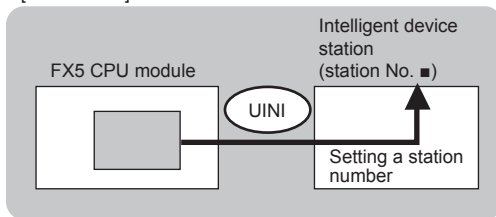

- The execution of the G(P).UINI instruction and whether it has been completed normally or completed with an error can be checked with the completion device (d) or completion status indication device (d)+1.

Device	Operation
Completion device (d)	The device turns on during the END processing for the scan in which the G(P).UINI instruction is completed, and turns off during the next END processing.
Completion status indication device (d)+1	The device turns on or off depending on the completion status of the G(P).UINI instruction. When completed normally: The device does not change (remains off). When completed with an error: The device turns on during the END processing for the scan in which the G(P).UINI instruction is completed, and turns off during the next END processing.

- The following figure shows the operation at completion of the G(P).UINI instruction.

■When completed normally

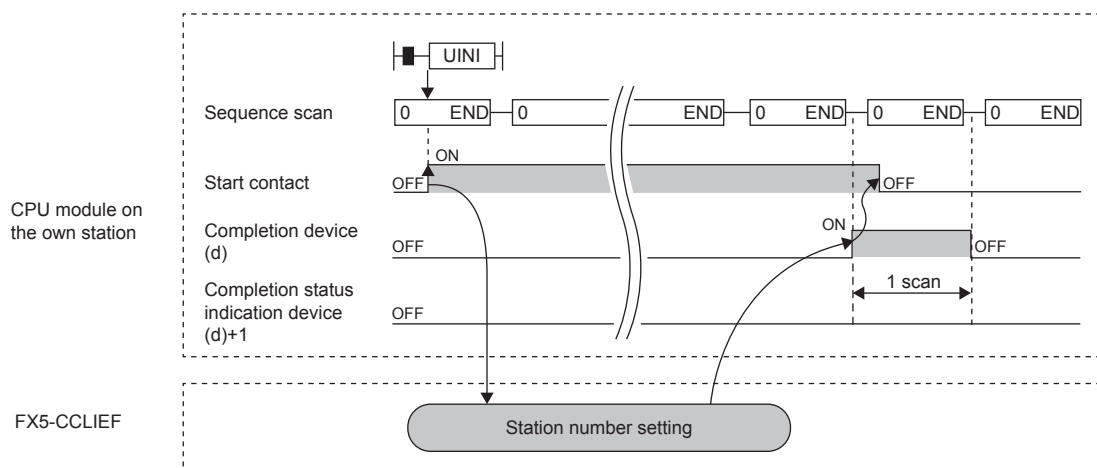

■When completed with an error

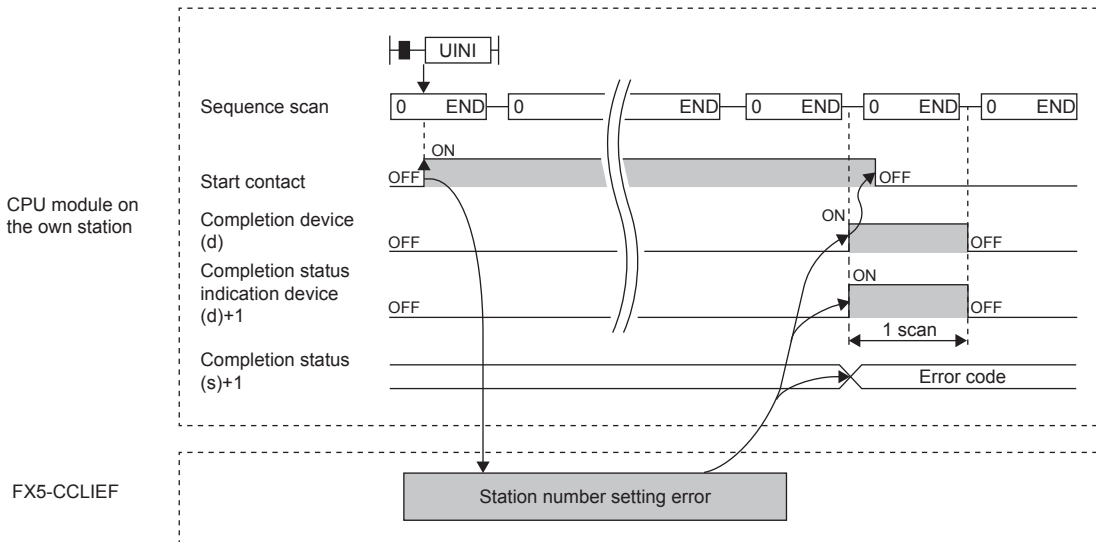

Operation error

Error code ((s)+1)	Description
D000H to DFFFH	Refer to Page 120 List of Error Codes.

Program example

The following program is for setting the station number stored in R0 of the FX5 CPU module into the intelligent device station when the switch on the CPU module is set to RUN.

- System configuration

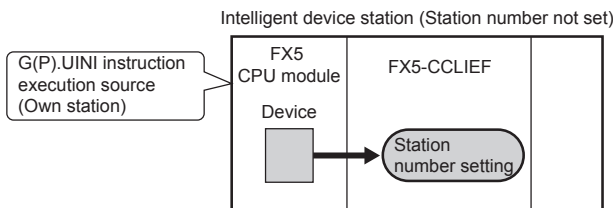

- Devices used

Device	Description
SB0046	Station number setting status of own station
M192	Completion device
M193	Completion status indication device
D600 to D609	Control data of the GP.UINI instruction (For the set value, refer to the following figure.)
R0	Station number storage device

- Control data

Device	Item	Set value
(s)+0	D600	Not used
(s)+1	D601	Completion status
(s)+2	D602	Change target specification
(s)+3	D603	Station number of own station
(s)+4 to (s)+9	D604 to D609	Not used

- Program

Write the following program to the FX5 CPU module.

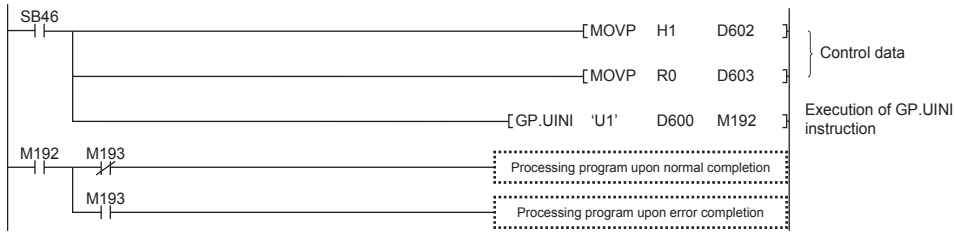

■ Program using module FB

Program as follows when using the module FB

- Devices used

Device	Description
SB0046	Station number setting status of own station
M191 to M193	Bit-type input output label for module FB (Refer to the following table for the setting.)
D603, D610	Word-type input output label for module FB (Refer to the following table for the setting.)
D2710, D2720, D2730 and D2740	Dummy device
R0	Station number storage device

- Instance name of module FB

Name of module FB	Instance name
M+FX5CCLIEF_StationNoSet	StationNoSet

- FX5-CCLIEF module label

Module label name	Module No.
FX5CCLIEF_1	No.1

- Label to be used

Label name	Item	Setting value/setting device
■Input label		
i_bEN	Execution command	—
i_stModule	Module label	FX5CCLIEF_1
i_uSetStationNo	Setting station number	R0 (D603)
■Output label		
o_bENO	Execution status	M191
o_bOK	Normal completion	M192
o_bErr	Abnormal end	M193
o_uErrId	Error code	D610

- Program

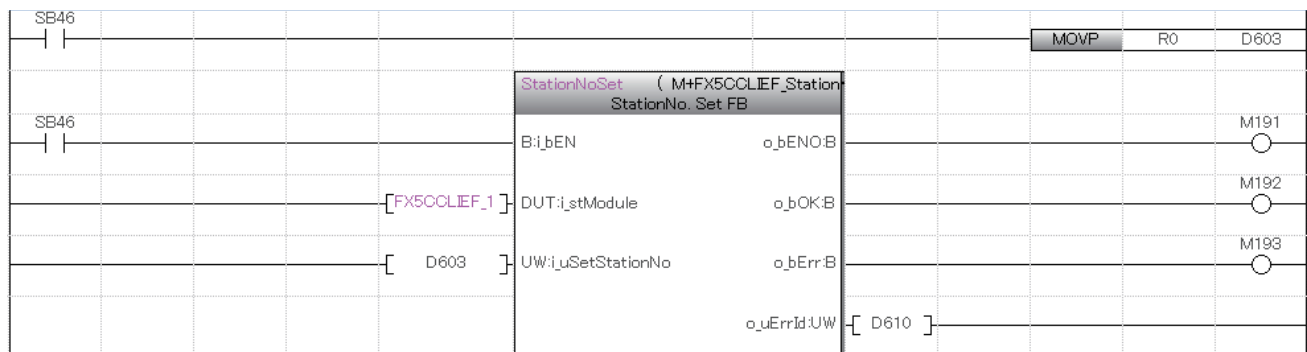

Add the processing program when completed successfully and completed with an error after the program above.

Operating procedure

The procedure of station number setting using the G(P).UINI instruction is as follows.

- 1.** Before setting parameters using the G(P).UINI instruction, set the following item in the network parameters of GX Works3.
 - Network Number: Set the desired value.
 - Setting Method: Select "Program".
 - Parameter Setting Method: Set the desired value.
- 2.** Create a G(P).UINI instruction program.
- 3.** Write parameters and programs to the FX5 CPU module through GX Works3.
- 4.** Execute the G(P).UINI instruction.

Precautions

- The station number set by the G(P).UINI instruction is cleared when the FX5 CPU module is powered off and on or reset.
- The G(P).UINI can be executed on the intelligent device station with no station number setting.
- If the station number set by the G(P).UINI instruction is already used for another station, the instruction is completed with an error. Set a unique station number. Note that such error cannot be detected before data link start (e.g. absence of the master station).

9 PROGRAMMING

This chapter describes programming and startup examples of CC-Link IE Field Network.

9.1 Procedure for Creating Programs

Cyclic transmission program

This is a program that performs the cyclic transmission in the master station (station No. 0) and intelligent device station (station No. 1).

Parameter settings

The parameter settings required to create a program are shown below.

- Network configuration setting (set in the master station)

STA#	Station Type	RX/RX Setting			RWw/RWr Setting		
		Points	Start	End	Points	Start	End
0	Master station	—	—	—	—	—	—
1	Intelligent device station	384	0000	017F	1024	0000	03FF

- Link refresh setting (set in the master station and intelligent device station)

No.	Link side				CPU side			
	Start	End	Points	Units	Start	End	Points	Units
1	RX0	RX17F	384	Bit	B0	B17F	384	Bit
2	RY0	RY17F	384	Bit	B200	B37F	384	Bit
3	RWr0	RWr3FF	1024	Word	W0	W3FF	1024	Word
4	RWw0	RWw3FF	1024	Word	W400	W7FF	1024	Word

Program example

This is a program that sends the value of D0 to D3 in the master station (station No. 0) to the D100 to D103 of the intelligent device station (station No. 1) through cyclic transmission. (B0 and B200 are used for a handshake to the CPU module.)

Device	Description
M0	Sending request
M10	Communication ready flag (for station No. 1)
M11	Communication ready flag (for station No. 0)
N0	Nesting
D0	Sending data (sending station)
D100	Sending data (receiving station)

- Sending station (station No. 0)

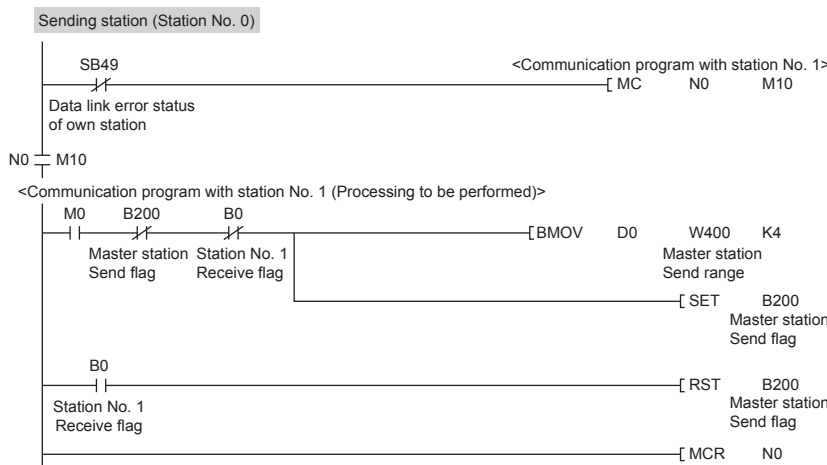

• Receiving station (station No. 1)

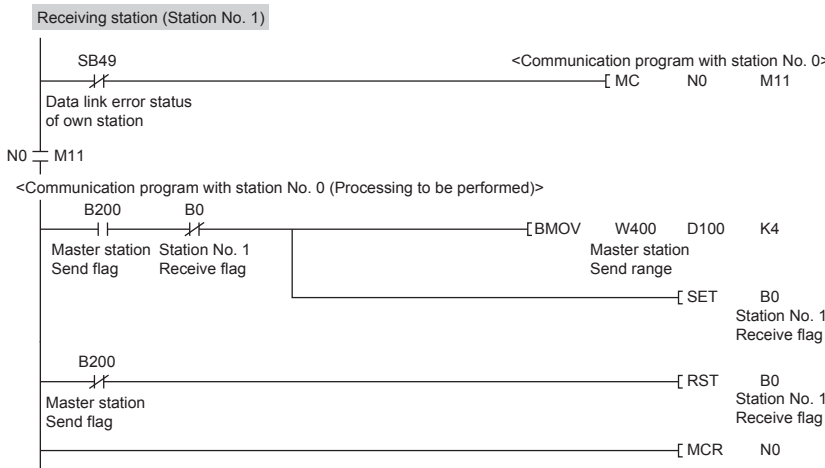

Precautions

For a cyclic transmission program, establish an interlock using the following link special relay (SB).

- Data link error status of own station (SB0049)

Ex.

Interlock example

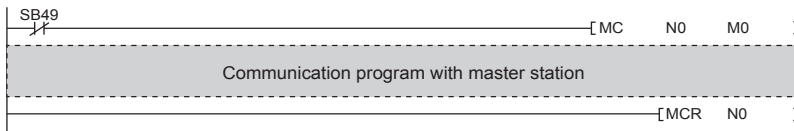

Transient transmission program

This is a program that reads D300 to D304 in the master station (station No. 0) to D800 to D804 of the intelligent device station (station No. 1) using the GP.READ instruction.

• Devices used

Device	Description
X20	Control data set command
X21	Read command
M0	Completion device (normal)
M1	Completion device (error)
D1000	Error completion type
D1002	Own station channel
D1003	Target station CPU type
D1004	Target network number
D1005	Target station number
D1007	Number of resends
D1008	Arrival monitoring time
D1009	Read data length
D300 to D304	Master station device where the data to be read is stored
D800 to D804	Own station device for storing the read data

• Program

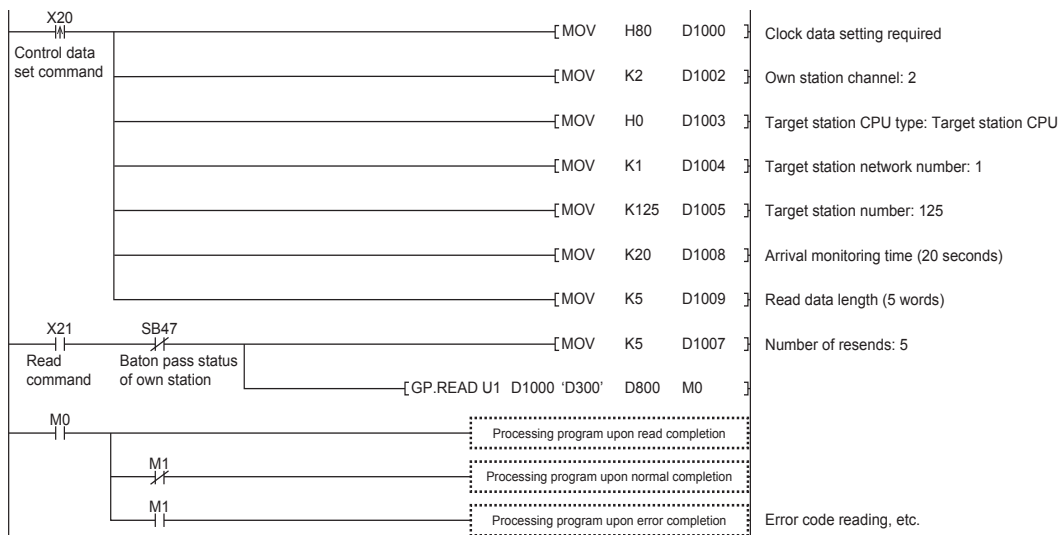

■ Program using module FB

Program as follows when using the module FB.

- Devices used

Device	Description
X20	Control data set command
X21	Read command
M0	Completion device (normal)
M1	Completion device (error)
M2	Execution status
D1002	Own station channel
D1003	Target station CPU type
D1004	Target network number
D1005	Target station number
D1007	Number of resends
D1008	Arrival monitoring time
D1009	Read data length
D1010	Error code
D300 to D304	Master station device where the data to be read is stored
D800 to D804	Own station device for storing the read data

- Instance name of module FB

Name of module FB	Instance name
M+FX5CCLIEF_DeviceRead	DeviceRead_2

- FX5-CCLIEF module label

Module label name	Module No.
FX5CCLIEF_1	No.1

- Label to be used

Label name	Item	Setting value/setting device
■Input label		
i_bEN	Execution command	—
i_stModule	Module label	FX5CCLIEF_1
i_u2TargetAddress	First word: target station network number	0 (D1003)
	Second word: Target station number	1 (D1004)
i_uDataLength	Read data length	5 words (D1009)
i_s32TargetDevice	Target station read device	D300
i_uChannel	Own station channel	2 (D1002)
■Output label		
o_bENO	Execution status	M2
o_bOK	Normal completion	M0
o_bErr	Abnormal end	M1
o_uErrId	Error code	D1010
o_uReadData	Read data storage device	D800

• Program

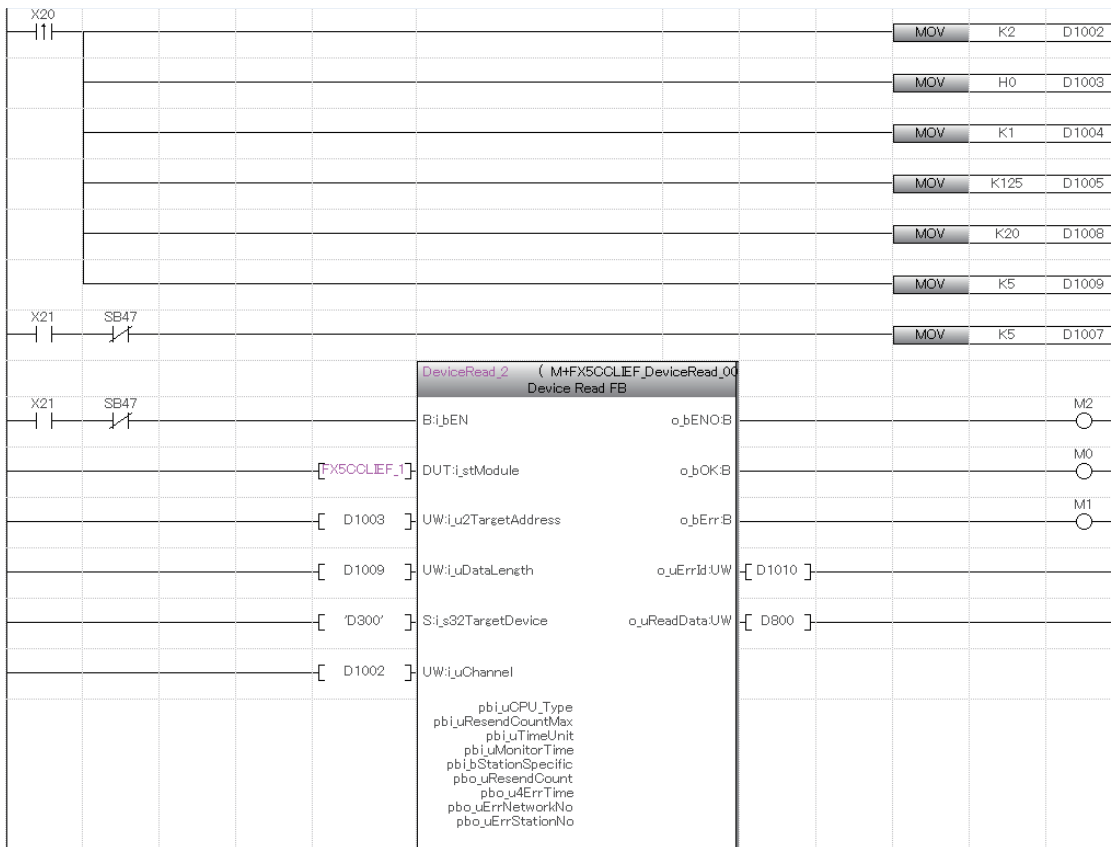

Add the processing program when read is completed and when completed successfully and completed with an error after the program above.

Precautions

For a transient transmission program, establish an interlock using the following link special relay (SB).

- Baton pass status of own station (SB0047)

Ex.

Interlock example



10 TROUBLESHOOTING

This chapter describes troubleshooting of CC-Link IE Field Network.

10.1 Checking with LEDs

This section describes troubleshooting using LED.

Error status can be determined by status of the RUN LED and the ERR LED.

RUN LED	ERR LED	Error status ^{*1}	Description
Off	On, flashing	Major error	An error such as hardware failure or memory failure. The module stops operating.
On	Flashing	Moderate error	An error, such as parameter error, which affect module operation. The module stops operating.
On	On	Minor error	An error such as communication failure. The module continues operating.

*1 When multiple errors occur, the error status is displayed in the order of major, moderate, and minor.

If the RUN LED turns off

When the RUN LED turns off after powering on the FX5-CCLIEF module, check the following.

Item to check	Action
Is the FX5-CCLIEF module mounted correctly?	Securely connect the FX5-CCLIEF module on the CPU module.

If the above action does not solve the problem, perform the module communication test to check for hardware failure.



( Page 113 Module communication test)

If the ERR LED turns on or is flashing

If the ERR LED is turned on or flashing, check the following items.

Item to check	Action
Does any error occur in the module diagnostics?	Take the actions displayed on the window.

If the above actions do not solve the problem, perform the following tests to check for an error.

- Module communication test ( Page 113 Module communication test)
- Cable test ( Page 117 Cable Test)

If the D. LINK LED turns off or is flashing

If the D. LINK LED is turned off or flashing, check the following items.

Item to check	Action
Is the master station connected to the network?	Check if the master station is performing data link using CC-Link IE Field Network diagnostics. (☞ Page 114 Checking the Network Status)
Do the used Ethernet cables conform to the Ethernet standard?	Replace the cables with an Ethernet cable that conforms to the standard. (☞ Page 14 Performance Specifications)
Does the station-to-station distance meet the specifications?	Set the station-to-station distance within range. (☞ Page 14 Performance Specifications)
Does the cabling condition (bending radius) meet the specifications?	Refer to the manual for the Ethernet cable, and correct the bending radius.
Is any Ethernet cable disconnected?	Replace the Ethernet cable.
Is a switching hub connected in ring topology?	Configure the network in ring topology without a switching hub.
Are other stations connected to the FX5-CCLIEF module operating normally?	Power off and on other stations.
Is the switching hub used operating normally?	<ul style="list-style-type: none"> • Check if the switching hub conforms to the standard. (☞ Page 14 Performance Specifications) • Power off and on the switching hub.
Check that the cables are not connected as described below. <ul style="list-style-type: none"> • Both P1 and P2 are connected to the same switching hub. • The network is incorrectly configured in ring topology. 	Correct the wiring. When the system does not contain a switching hub, take the following action: <ul style="list-style-type: none"> • Disconnect an Ethernet cable (either P1 or P2) connected to any station on the network. The network topology will become a line topology and data link will start. When the system contains a switching hub, take any of the following actions: <ul style="list-style-type: none"> • Disconnect one Ethernet cable connected to the switching hub and power off and on the hub. (Repeat this operation until data link starts over the network.) • When data link starts over the network, check the network configuration using CC-Link IE Field Network diagnostics.
Are station numbers unique?	Change the duplicated station number.

If the above actions do not solve the problem, perform the following tests to check for an error.

- Module communication test (☞ Page 113 Module communication test)
- Cable test (☞ Page 117 Cable Test)

If the L ERR LED is turned on

If the L ERR LED is turned on, check the following items.

Item to check	Action
Are the Ethernet cables used operating normally?	<ul style="list-style-type: none">• Check if the Ethernet cable conforms to the standard. (☞ Page 14 Performance Specifications)• Check if the station-to-station distance is set within range. (☞ Page 14 Performance Specifications)• Check if the Ethernet cables are not disconnected.
Is the switching hub used operating normally?	<ul style="list-style-type: none">• Check if the switching hub conforms to the standard. (☞ Page 14 Performance Specifications)• Power off and on the switching hub.
Are other stations connected to the FX5-CCLIEF module operating normally?	Power off and on other stations.
Is "Module Operation Mode" under "Application Settings" of the master station set to "Online"?	Set the master station mode to online.
Is there any source of noise near the module or cables?	Change the location of the module or cables.
Is the loopback function enabled for the master station?	When the loopback function is enabled, check if the ring topology is correctly configured for the port where the L ERR LED is on.

If the above actions do not solve the problem, perform troubleshooting for when communication is unstable. (☞ Page 119 When communication is unstable)

If the LINK LED turns off

If the LINK LED is turned off, check the following items.

Item to check	Action
Do the used Ethernet cables conform to the Ethernet standard?	Replace the cables with an Ethernet cable that conforms to the standard. (☞ Page 35 Ethernet cable)
Does the station-to-station distance meet the specifications?	Set the station-to-station distance within range. (☞ Page 14 Performance Specifications)
Does the cabling condition (bending radius) meet the specifications?	Refer to the manual for the Ethernet cable, and correct the bending radius.
Is any Ethernet cable disconnected?	Replace the Ethernet cable.
Is the switching hub used operating normally?	<ul style="list-style-type: none">• Check if the switching hub conforms to the standard. (☞ Page 35 Hub)• Power off and on the switching hub.
Are other stations connected to the FX5-CCLIEF module operating normally?	Power off and on other stations.

If the above actions do not solve the problem, perform the following tests to check for an error.

- Module communication test (☞ Page 113 Module communication test)
- Cable test (☞ Page 117 Cable Test)

10.2 Checking the Module Status

Module communication test

The module communication test checks the hardware of the FX5-CCLIEF. Select this mode to check the module hardware when communication of FX5-CCLIEF is unstable.

The following table lists the tests performed.

Test item	Description
H/W test	Checks whether the microcomputer and RAM can be accessed normally.
Internal self-loopback test	Checks whether the communication function of the module can be performed normally.
External self-loopback check	Checks the connection failure by self-loopback check of the cable.
External self-loopback communication test	Checks whether the communication can be performed normally with the cable connected between two connectors.

■Procedure

1. Set the following item to "Module Communication Test".

 Navigation window ⇒ [Parameter] ⇒ [Module Information] ⇒ Target module ⇒ [Module Parameter] ⇒ [Application Settings] ⇒ [Module Operation Mode]

2. Connect P1 and P2 of the FX5-CCLIEF with an Ethernet cable.

3. Write the module parameters to the FX5 CPU module.

4. Reset or power off and on the FX5 CPU module to start the module communication test.

Point

- Do not access the buffer memory during the test. Doing so may cause the test to fail.
- Do not perform a module communication test while connected to another station. The operation of the other station may fail.

■Checking the status and result of module communication test

The test status and result can be checked with LED display of the module.

Test status	LED display
Test in progress	The dot matrix LED displays "UCT".
Normal completion	The dot matrix LED displays "OK".
Abnormal completion	The ERR LED turns on and the dot matrix LED displays "ERR" and error number alternately at intervals of 1 second.

■Error number when the test abnormally ended

The dot matrix LED displays the error number with the form of "Port number Error number".

For example, "1 3" is displayed when error No. 3 occurs in P1.

If the module communication test fails, check the following.

Error number	Description	Action
1	Internal self-loopback test failure	Consult your local Mitsubishi Electric representative.
2	External self-loopback communication test connection error	Check the Ethernet cable connection or replace the Ethernet cable, and perform the test again. If the test fails again, please consult your local Mitsubishi Electric representative.
3	External self-loopback communication test communication error	Replace the Ethernet cable and perform the test again. If the test fails again, please consult your local Mitsubishi Electric representative.

Precautions

When "0" is displayed as the port number, the H/W test may have failed. Consult your local Mitsubishi Electric representative.

10.3 Checking the Network Status

Perform the CC-Link IE Field Network diagnostics to check the network status and error details or to perform an operation test for troubleshooting.

Diagnostic items

The following table lists items of the FX5-CCLIEF that can be diagnosed by the CC-Link IE Field Network diagnostics.

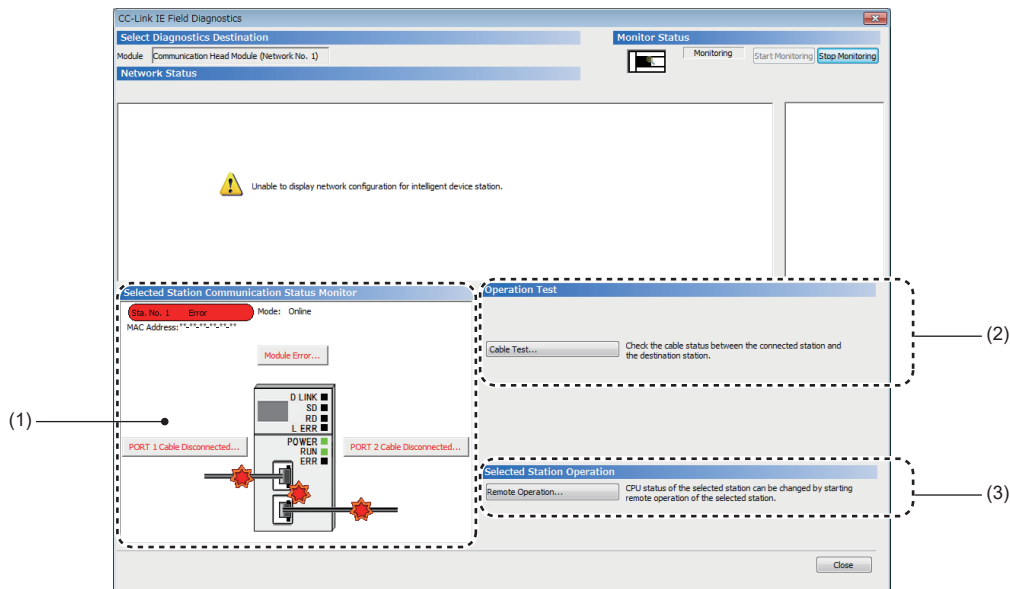

Item	Restrictions	Reference
(1) Selected Station Communication Status Monitor	Displays the communication status of the own station. If an error has occurred in the module, the diagnostics information such as cause of error and corrective action is displayed.	Page 116
(2) Cable Test	Tests the connection status of the station-to-station cable connected to P1 or P2 of the own station.	Page 117
(3) Remote Operation	Performs remote operations (such as RUN, STOP, or RESET operations) to the FX5 CPU module of the own station.	Page 117

Starting diagnostics

This section describes how to use the CC-Link IE Field Network diagnostics.

1. Connect the engineering tool to the FX5 CPU module.
2. Start the CC-Link IE Field Network diagnostics.

[Diagnostics] ⇒ [CC-Link IE Field Diagnostics]

3. The status of the own station is displayed on the "Selected Station Communication Status Monitor". The status of the own station is displayed on the top of "Selected Station Communication Status Monitor". If an error occurs, a button indicating the error such as [PORT2 Communication Error] is displayed in "Selected Station Communication Status Monitor". Click the button to check the error details and actions.

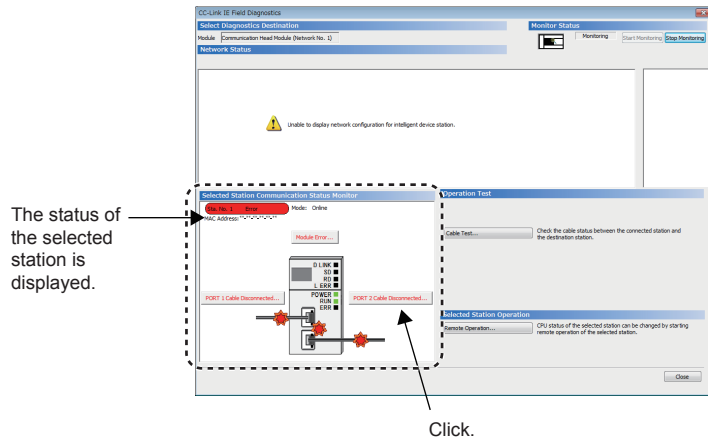

4. Cable test and remote operation can be performed by clicking the "Operation Test" or "Selected Station Operation" on the bottom right of the window. (Page 117 Cable Test, Page 117 Remote Operation)

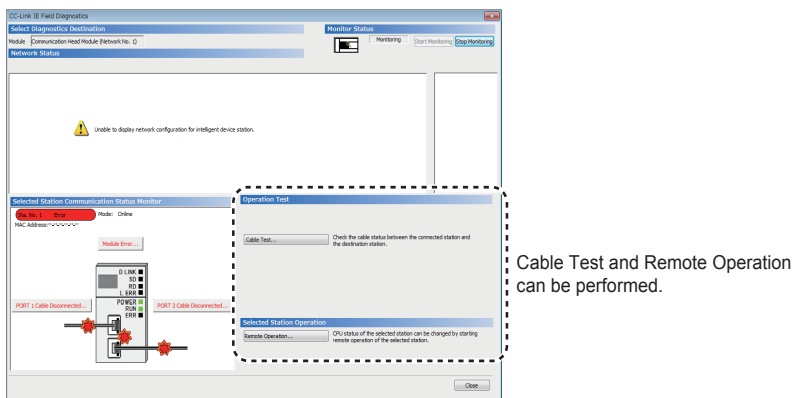

Selected Station Communication Status Monitor

The status of the own station is displayed.

■When an error occurs

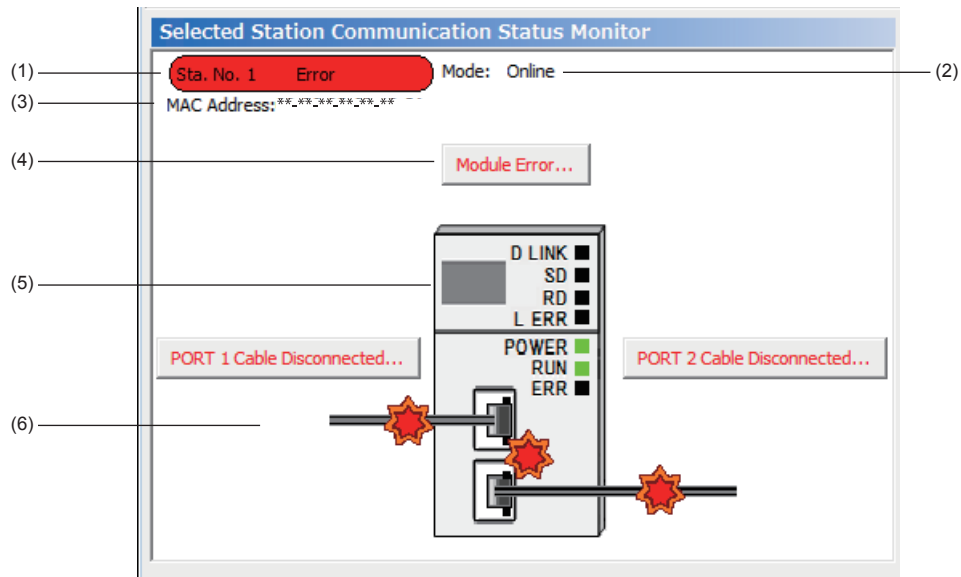

No.	Description
(1)	Displays the operating status. <ul style="list-style-type: none"> • Station No.□: Normal operation • Station No.□ Error (yellow): Error (Data link is continued.) • Station No.□ Error (red): Error (Data link is stopped.)
(2)	Displays a mode.
(3)	Displays a MAC address.
(4)	Click this button to check error details. Take actions following the description displayed in "Error Factor" and "Troubleshooting".
(5)	Displays LED on/off status of the own station module. (☞ Page 16 LED display)
(6)	Displays status of the cables connected to P1 and P2.

Cable Test

Cable test checks if the Ethernet cables are properly connected.
Only the Ethernet cable connected to P1 or P2 of the own station is tested.

Procedure

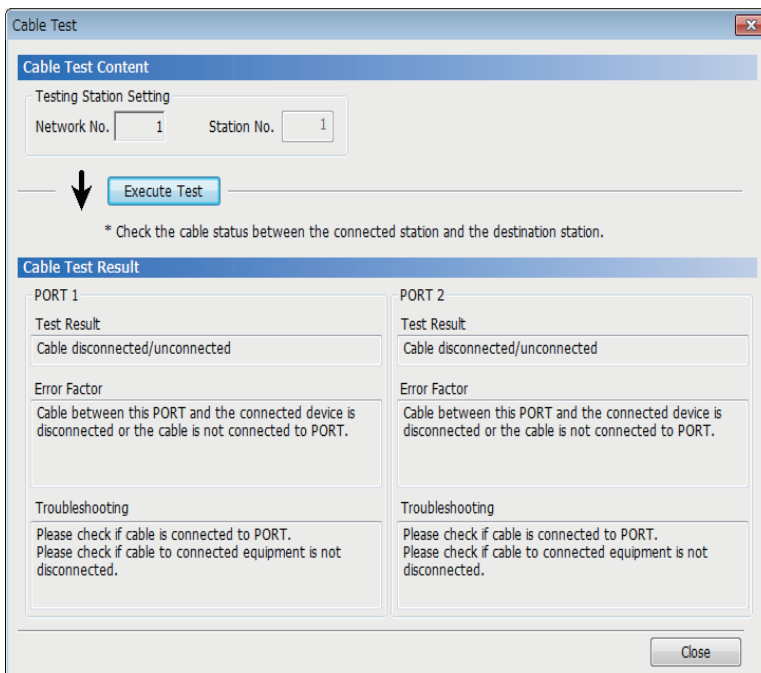

1. Click the [Cable Test] button in the "CC-Link IE Field Diagnostics" window.
"Cable Test" window is displayed.
2. Click the [Execute Test] button.
If an error occurs, take actions according to the error message.

10

Remote Operation

This function executes remote operations (such as RUN, STOP, and RESET operations) to the own station from the engineering tool.

Procedure

To perform remote operations, follow the steps below.

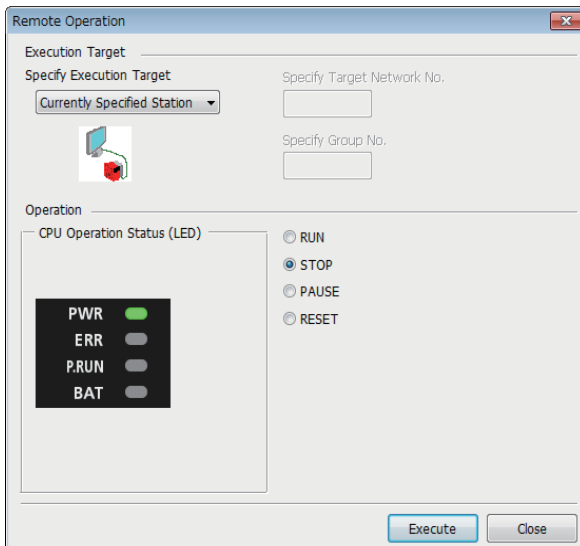

1. Click the [Remote Operation] button in the "CC-Link IE Field Diagnostics" window.
"Remote Operation" window is displayed.
2. Select a remote operation (RUN, STOP, PAUSE, or RESET) to be performed in "Operation" for FX5 CPU module. *1
3. Click the [Execute] button to perform the remote operation.

*1 To perform remote RESET, preset "Remote Reset Setting" under "Operation Related Setting" to "Enable" in the CPU Parameters.

10.4 Troubleshooting for Each Symptom

This section describes troubleshooting method by symptom. Perform these troubleshooting if data link cannot be performed even though no error is detected in the intelligent device station. If an error has occurred in the intelligent device station, identify the cause of error using the engineering tool. (☞ Page 114 Checking the Network Status)

When cyclic transmission cannot be performed

The following lists the actions to be taken if cyclic transmission to the master station cannot be performed.

Item to check	Action
Is the D. LINK LED of the master or intelligent device station turned off or flashing?	Perform troubleshooting for when the D. LINK LED turns off or is flashing. (☞ Page 111 If the D. LINK LED turns off or is flashing)
Do the station numbers set in "Network Configuration Settings" under "Basic Settings" of the master station match those set for corresponding slave stations?	Correct station numbers.
Is the range set in "Refresh Setting" of "Basic Settings" correct?	Correct the range setting in "Refresh Setting" of "Basic Settings". (☞ Page 38 Refresh setting)
Is any used device in "Refresh Setting" of "Basic Settings" overlapped with that of another module?	Correct the range setting in "Refresh Setting" of "Basic Settings". (☞ Page 38 Refresh setting)
Is the station number of the intelligent device station duplicated with any of the other stations?	Change the duplicated station number.
Is the module parameter of the I/O module connected to the CPU module written?	Correct the [Parameter] ⇒ [Module Information] settings.

If the above action does not solve the problem, perform the module communication test to check for hardware failure. (☞ Page 113 Module communication test)

When transient transmission cannot be performed

The following lists the actions to be taken if transient transmission cannot be performed with the target station, and the engineering tool cannot perform monitoring.

Item to check	Action
Is the D. LINK LED of the master or intelligent device station turned off?	Perform troubleshooting for when the D. LINK LED turns off or is flashing. (☞ Page 111 If the D. LINK LED turns off or is flashing)
Is the baton pass status of the destination normal?	In the CC-Link IE Field Network diagnostics, identify the cause of the error and take action. (☞ Page 114 Checking the Network Status)
Are the following control data of the dedicated instruction correct? <ul style="list-style-type: none"> • CPU type of the target module • Target network number • Target station number 	Correct the control data of the dedicated instruction.
Is the station number of the intelligent device station duplicated with any of the other stations?	Change the duplicated station number.

If the above actions do not solve the problem, perform the following tests to check for an error.

- Module communication test (☞ Page 113 Module communication test)

When a station is disconnected from the network

The following is the action to be taken when a station in data link is disconnected.

Item to check	Action
Is the ambient temperature for the module within the specified range?	Keep the ambient temperature within the specified range by taking action such as removing heat source.

If the above actions do not solve the problem, perform the following tests to check for an error.

- Module communication test (☞ Page 113 Module communication test)
- Cable test (☞ Page 117 Cable Test)

When a station is repeatedly disconnected and reconnected

The following lists the actions to be taken when a station in data link is repeatedly disconnected and reconnected.

Item to check	Action
Are 1000BASE-T-compliant Ethernet cable used?	Replace the cables with 1000BASE-T-compliant Ethernet cables. (☞ Page 35 Ethernet cable)
Is the station-to-station distance 100 m or less?	Change the station-to-station distance to 100 m or less.
Does the cabling condition (bending radius) meet the specifications?	Refer to the manual for the Ethernet cable, and correct the bending radius.
Is any Ethernet cable disconnected?	Replace the Ethernet cable.
Is the switching hub used in the system operating normally?	<ul style="list-style-type: none"> • Check if a 1000BASE-T-compliant switching hub is used. (☞ Page 35 Hub) • Power off and on the switching hub.

If the above actions do not solve the problem, perform the following tests to check for an error.

- Module communication test (☞ Page 113 Module communication test)
- Cable test (☞ Page 117 Cable Test)

When communication is unstable

The following lists the actions to be taken when link scan time or transmission delay time is long or when a transient transmission timeout occurred.

Item to check	Action
Is the L ERR LED of the master or intelligent device station turned on?	Perform troubleshooting for when the L ERR LED turns on. (☞ Page 112 If the L ERR LED is turned on)
Is the ambient temperature for the module within the specified range?	Keep the ambient temperature within the specified range by taking action such as removing heat source.
Is any error shown in "Selected Station Communication Status Monitor" of CC-Link IE Field Network diagnostics?	If an error is identified at P1 or P2, perform a cable test and a module communication test.
Is there any noise affecting the system?	Check the wiring condition.

If the above actions do not solve the problem, perform the following tests to check for an error.

- Module communication test (☞ Page 113 Module communication test)
- Cable test (☞ Page 117 Cable Test)

10.5 List of Error Codes

This section lists the error codes, error details and causes, and action for errors that occur in the processing for data communication between FX5-CCLIEF and external devices or caused by processing requests from the FX5 CPU module on the own station.

Error code	Error details and causes	Action
D000H	An error was detected in the network module.	<ul style="list-style-type: none"> Take measures to reduce noise. Execute the module communication test. If the error occurs again even after taking the above action, hardware failure is a possible cause. Consult your local Mitsubishi Electric representative.
D001H	An error was detected in the network module.	<ul style="list-style-type: none"> Take measures to reduce noise. Execute the module communication test. If the error occurs again even after taking the above action, hardware failure is a possible cause. Consult your local Mitsubishi Electric representative.
D003H	An error was detected in the network module.	<ul style="list-style-type: none"> Take measures to reduce noise. Execute the module communication test. If the error occurs again even after taking the above action, hardware failure is a possible cause. Consult your local Mitsubishi Electric representative.
D004H	An error was detected in the network module.	<ul style="list-style-type: none"> Take measures to reduce noise. Execute the module communication test. If the error occurs again even after taking the above action, hardware failure is a possible cause. Consult your local Mitsubishi Electric representative.
D00FH	An error was detected in the network module.	<ul style="list-style-type: none"> Take measures to reduce noise. Execute the module communication test. If the error occurs again even after taking the above action, hardware failure is a possible cause. Consult your local Mitsubishi Electric representative.
D03AH	A station that does not support the SLMP function was found.	Check whether the station supports the function. If the station does not support the used function, replace it with a station with the latest version.
D080H	An error was detected in the network module.	<ul style="list-style-type: none"> Take measures to reduce noise. Execute the module communication test. If the error occurs again even after taking the above action, hardware failure is a possible cause. Consult your local Mitsubishi Electric representative.
D081H	An error was detected in the network module.	<ul style="list-style-type: none"> Take measures to reduce noise. Execute the module communication test. If the error occurs again even after taking the above action, hardware failure is a possible cause. Consult your local Mitsubishi Electric representative.
D082H	An error was detected in the network module.	<ul style="list-style-type: none"> Take measures to reduce noise. Execute the module communication test. If the error occurs again even after taking the above action, hardware failure is a possible cause. Consult your local Mitsubishi Electric representative.
D083H	An error was detected in the network module.	<ul style="list-style-type: none"> Take measures to reduce noise. Execute the module communication test. If the error occurs again even after taking the above action, hardware failure is a possible cause. Consult your local Mitsubishi Electric representative.
D0A0H	Transmission response wait timeout has occurred in transient transmission.	<ul style="list-style-type: none"> When the own station, target station, or relay station detected an error, identify the cause of the error and take action. Lower the transient transmission usage frequency, and then perform again. When "Communication Mode" in "Application Settings" of the master station (submaster station) is set to "High-Speed", change it to "Normal" and retry the operation.
D0A1H	Transmission completion wait timeout has occurred in transient transmission.	<ul style="list-style-type: none"> Lower the transient transmission usage frequency, and then perform again. Check if the switching hub and the cables at the request source are connected properly. Connect the cable to the other port, and retry the operation. Execute the module communication test. If the error occurs again even after taking the above action, hardware failure is a possible cause. Consult your local Mitsubishi Electric representative.
D0A2H	Transmission processing wait timeout has occurred in transient transmission.	<ul style="list-style-type: none"> Lower the transient transmission usage frequency, and then perform again. Check if the switching hub and the cables at the request source are connected properly.
D0A3H	Send processing of the transient transmission has failed.	<ul style="list-style-type: none"> When the own station, target station, or relay station detected an error, identify the cause of the error and take action. Correct the target station number of transient data, and retry the operation.

Error code	Error details and causes	Action
D0A4H	Transient transmission failed.	<ul style="list-style-type: none"> Lower the transient transmission usage frequency, and then perform again. Check if the switching hub and the cables at the request source are connected properly. Connect the cable to the other port, and retry the operation. Execute the module communication test. If the error occurs again even after taking the above action, hardware failure is a possible cause. Consult your local Mitsubishi Electric representative.
D0A5H	Transient transmission failed.	<ul style="list-style-type: none"> Lower the transient transmission usage frequency, and then perform again. Check if the switching hub and the cables at the request source are connected properly. Connect the cable to the other port, and retry the operation. Execute the module communication test. If the error occurs again even after taking the above action, hardware failure is a possible cause. Consult your local Mitsubishi Electric representative.
D0A6H	Transient transmission failed.	<ul style="list-style-type: none"> Lower the transient transmission usage frequency, and then perform again. Check if the switching hub and the cables at the request source are connected properly. Connect the cable to the other port, and retry the operation. Execute the module communication test. If the error occurs again even after taking the above action, hardware failure is a possible cause. Consult your local Mitsubishi Electric representative.
D0A8H	An error was detected in the network module.	<ul style="list-style-type: none"> Take measures to reduce noise. Execute the module communication test. If the error occurs again even after taking the above action, hardware failure is a possible cause. Consult your local Mitsubishi Electric representative.
D0A9H	An error was detected in the network module.	<ul style="list-style-type: none"> Take measures to reduce noise. Execute the module communication test. If the error occurs again even after taking the above action, hardware failure is a possible cause. Consult your local Mitsubishi Electric representative.
D0E1H	The reserved station setting of the own station is incorrect.	<ul style="list-style-type: none"> In the network configuration settings of the master station (submaster station), cancel the reserved station setting. Change the station number of the own station to a station number that is not specified as a reserved station.
D0E2H	The station number of own station is already used for the other station.	<ul style="list-style-type: none"> Set a unique station number. After change, power off and on or reset all stations where the error was detected.
D0F0H	An error was detected in the network module.	<ul style="list-style-type: none"> Take measures to reduce noise. Execute the module communication test. If the error occurs again even after taking the above action, hardware failure is a possible cause. Consult your local Mitsubishi Electric representative.
D100H	An error was detected in the network module.	<ul style="list-style-type: none"> Take measures to reduce noise. Execute the module communication test. If the error occurs again even after taking the above action, hardware failure is a possible cause. Consult your local Mitsubishi Electric representative.
D101H	An error was detected in the network module.	<ul style="list-style-type: none"> Take measures to reduce noise. Execute the module communication test. If the error occurs again even after taking the above action, hardware failure is a possible cause. Consult your local Mitsubishi Electric representative.
D110H	An error was detected in the network module.	<ul style="list-style-type: none"> Take measures to reduce noise. Execute the module communication test. If the error occurs again even after taking the above action, hardware failure is a possible cause. Consult your local Mitsubishi Electric representative.
D200H	When the transient transmission was executed, data was received twice.	<ul style="list-style-type: none"> Check the network status using the CC-Link IE Field Network diagnostics of the engineering tool, and take action. Check if the switching hub and the cables at the request source are connected properly.
D201H	The header information of transient transmission is incorrect.	Correct the header information at the request source, and retry the operation.
D202H	The send buffer is full.	<ul style="list-style-type: none"> Lower the transient transmission usage frequency, and then perform again. When "Communication Mode" in "Application Settings" of the master station (submaster station) is set to "High-Speed", change it to "Normal" and retry the operation. Check if the switching hub and the cables at the request source are connected properly.
D204H	The network number of transient transmission is incorrect.	Correct the network number at the request source, and retry the operation.
D205H	The target station number of transient transmission is incorrect.	Correct the target station number at the request source, and retry the operation.
D206H	The network number of transient transmission is incorrect.	Correct the network number at the request source, and retry the operation.

Error code	Error details and causes	Action
D207H	In transient transmission, the number of relay to other networks exceeded seven.	Change the system configuration so that the number of relay stations may be seven or less.
D208H	The network number of transient transmission is incorrect.	Correct the network number at the request source, and retry the operation.
D209H	The target station number of transient transmission is incorrect.	Correct the target station number at the request source, and retry the operation.
D20AH	The target station number of transient transmission is incorrect.	Correct the target station number at the request source, and retry the operation.
D20BH	When there was no master station, specified master station was specified for transient transmission.	Correct the target station number at the request source, and retry the operation.
D20CH	When there was no master station, current master station was specified for transient transmission.	Correct the target station number at the request source, and retry the operation.
D20DH	Transmission completion wait timeout has occurred in transient data transmission.	<ul style="list-style-type: none"> • Check the network status using the CC-Link IE Field Network diagnostics of the engineering tool, and take action. • When the own station, target station, or relay station detected an error, identify the cause of the error and take action. • Lower the transient transmission usage frequency, and then perform again. • When "Communication Mode" in "Application Settings" of the master station (submaster station) is set to "High-Speed", change it to "Normal" and retry the operation. • Check if the switching hub and the cables at the request source are connected properly.
D20EH	The header information of transient transmission is incorrect.	Correct the header information at the request source, and retry the operation.
D20FH	In transient transmission, the command which cannot be requested to all or a group of stations was executed with all stations specification or group specification.	Check that the command can be requested to all or a group of stations at the request source, and retry the operation.
D210H	The target station number of transient transmission is incorrect.	Correct the header information at the request source, and retry the operation.
D211H	Transient transmission was performed when the station number of the own station has not been set yet.	Set the station number by the parameters, and perform transient transmission again.
D212H	Transient transmission failed.	<ul style="list-style-type: none"> • Check if the switching hub and the cables at the request source are connected properly. • Connect the cable to the other port on the request source, and retry the operation. • Lower the transient transmission usage frequency, and then perform again.
D213H	The command of transient transmission is incorrect.	<ul style="list-style-type: none"> • Correct the request command at the request source, and retry the operation. • Check whether the module supports the function. If the module does not support the used function, replace it with a module with the latest version.
D214H	The data length of transient transmission is incorrect.	Correct the data length at the transient request source, and retry the operation.
D216H	The command of transient transmission is incorrect.	Correct the request command at the request source, and retry the operation.
D217H	The command of transient transmission is incorrect.	Correct the request command at the request source, and retry the operation.
D218H	The number of read/write data of transient transmission is incorrect.	Correct the number of read or write device data at the request source, and retry the operation.
D219H	The attribute code of transient transmission is incorrect.	Correct the attribute code at the request source, and retry the operation.
D21AH	The access code of transient transmission is incorrect.	Correct the access code at the request source, and retry the operation.
D21BH	A transient transmission error was detected.	<ul style="list-style-type: none"> • Abnormal transient data were issued from the CPU module. • Replace the CPU module and retry the operation. • If the error occurs again even after taking the above action, please consult your local Mitsubishi representative.
D21DH	The network number of transient transmission is incorrect.	<ul style="list-style-type: none"> • A cable test cannot be executed for a different network. Correct "Testing Station Setting", and execute the cable test again. • Transient data that cannot be sent to a different network were received. Correct the network number or the target station number at the request source, and retry the operation.
D21EH	The target station number of transient transmission is incorrect.	<ul style="list-style-type: none"> • A communication test cannot be executed on a relay sending station. Correct "Target Station" setting, and execute the communication test again. • Transient data of the application type that cannot be executed on the own station were received. Correct the application type or the target station number at the request source, and retry the operation.

Error code	Error details and causes	Action
D220H	The master station does not exist.	Add the master station to the network.
D238H	The send queue is full.	<ul style="list-style-type: none"> • Pause the transient transmission temporarily, and retry the operation. • Lower the transient transmission usage frequency, and then perform again. • If the error occurs again even after taking the above action, please consult your local Mitsubishi representative.
D239H	SLMP transmission failed.	<ul style="list-style-type: none"> • Retry the operation after a while. • If the error occurs again even after taking the above action, please consult your local Mitsubishi representative.
D23AH	The subheader in the SLMP data is incorrect.	Correct the subheader information at the request source, and retry the operation.
D23BH	The network number in the SLMP data is incorrect.	Correct the network number at the request source, and retry the operation.
D23CH	The target station number in the SLMP data is incorrect.	Correct the station number at the request source and retry the operation.
D240H	The network number specification of the dedicated instruction is incorrect.	Execute again after correcting the network number at the request source.
D242H	The command code of the dedicated instruction is incorrect.	Execute again after correcting the command code at the request source.
D243H	The channel specified in the dedicated instruction is incorrect.	Execute again after correcting the used channel within the allowable range at the request source.
D244H	The transient data is incorrect.	<ul style="list-style-type: none"> • Correct the transient data at the request source, and retry the operation. • If the error occurs again even after taking the above action, please consult your local Mitsubishi representative.
D245H	The target station number of the dedicated instruction is incorrect.	Execute again after correcting the target station number at the request source.
D246H	The transient data is incorrect.	<ul style="list-style-type: none"> • Correct the transient data at the request source, and retry the operation. • If the error occurs again even after taking the above action, please consult your local Mitsubishi representative.
D247H	When the dedicated instruction was executed, response from the target station was received twice.	<ul style="list-style-type: none"> • Check the network status using the CC-Link IE Field Network diagnostics of the engineering tool, and take action. • Check if the switching hub and the cables at the request source are connected properly.
D248H	The transient data is incorrect.	<ul style="list-style-type: none"> • Correct the transient data at the request source, and retry the operation. • If the error occurs again even after taking the above action, please consult your local Mitsubishi representative.
D249H	The target station's CPU type of the dedicated instruction is incorrect.	Execute again after correcting the CPU type of the target station at the request source.
D24AH	The arrival monitoring time of the dedicated instruction is incorrect.	<ul style="list-style-type: none"> • Execute again after correcting the arrival monitoring time at the request source. • When the own station, target station, or relay station detected an error, identify the cause of the error and take action. • Lower the transient transmission usage frequency, and then perform again. • When "Communication Mode" in "Application Settings" of the master station (submaster station) is set to "High-Speed", change it to "Normal" and retry the operation. • Check if the switching hub and the cables at the request source are connected properly.
D24BH	The number of resends specified in the dedicated instruction is incorrect.	<ul style="list-style-type: none"> • Execute again after correcting the number of resends at the request source. • When the own station, target station, or relay station detected an error, identify the cause of the error and take action. • Lower the transient transmission usage frequency, and then perform again. • When "Communication Mode" in "Application Settings" of the master station (submaster station) is set to "High-Speed", change it to "Normal" and retry the operation. • Check if the switching hub and the cables at the request source are connected properly.
D24CH	The network number specification of the dedicated instruction is incorrect.	Execute again after correcting the network number at the request source.
D24DH	The channel specified in the dedicated instruction is incorrect.	• Set 1 to 2 for the target channel number in the control data when executing the SEND instruction.
D24EH	Target station setting error in the dedicated instruction	<ul style="list-style-type: none"> • The value set for the control block of the dedicated instruction is out of range. Execute again after correcting the value. • If the error occurs again even after taking the above action, please consult your local Mitsubishi representative.
D24FH	The dedicated instruction was executed when the station number of the own station has not been set yet.	<ul style="list-style-type: none"> • Specify the station number using the network parameter, and execute the instruction again. • If the error occurs again even after taking the above action, please consult your local Mitsubishi representative.

Error code	Error details and causes	Action
D251H	When the dedicated instruction was executed, arrival check error has occurred.	<ul style="list-style-type: none"> Execute again after increasing the number of resends at the request source. When the own station, target station, or relay station detected an error, identify the cause of the error and take action. Lower the transient transmission usage frequency, and then perform again. When "Communication Mode" in "Application Settings" of the master station (submaster station) is set to "High-Speed", change it to "Normal" and retry the operation. Check if the switching hub and the cables at the request source are connected properly.
D252H	Transmission completion wait timeout has occurred when the dedicated instruction was executed.	<ul style="list-style-type: none"> Check the network status using the CC-Link IE Field Network diagnostics of the engineering tool, and take action. Execute again after increasing the number of resends at the request source. Lower the transient transmission usage frequency, and then perform again. When "Communication Mode" in "Application Settings" of the master station (submaster station) is set to "High-Speed", change it to "Normal" and retry the operation. Correct the number of link dedicated instructions that have been simultaneously executed within the range. If the error occurs again even after taking the above action, please consult your local Mitsubishi representative.
D253H	A response timeout has occurred when the dedicated instruction was executed.	<ul style="list-style-type: none"> Check the network status using the CC-Link IE Field Network diagnostics of the engineering tool, and take action. Execute again after increasing the number of resends at the request source. Lower the transient transmission usage frequency, and then perform again. Correct the number of link dedicated instructions that have been simultaneously executed within the range. If the error occurs again even after taking the above action, please consult your local Mitsubishi representative.
D254H	A dedicated instruction which the target station does not support was executed.	<ul style="list-style-type: none"> Change the target station at the station that executed the SEND instruction. If the error occurs again even after taking the above action, please consult your local Mitsubishi representative.
D255H	The target station number of the dedicated instruction is incorrect.	<ul style="list-style-type: none"> Execute again after correcting the target station number in the control data. If the error occurs again even after taking the above action, please consult your local Mitsubishi representative.
D256H	The execution/error completion type of the dedicated instruction is incorrect.	<ul style="list-style-type: none"> Execute again after correcting the execution/error completion type in the control data. If the error occurs again even after taking the above action, please consult your local Mitsubishi representative.
D258H	The control station does not exist when the dedicated instruction was executed to the specified control station or current control station.	<ul style="list-style-type: none"> Execute again after correcting the target station number in the control data. If the error occurs again even after taking the above action, please consult your local Mitsubishi representative.
D25AH	The dedicated instruction was executed specifying the channel in use.	<ul style="list-style-type: none"> Retry the operation after a while. Change the channels used by own station or the target station's channel in the control data.
D25BH	The dedicated instruction was executed specifying the channel in use.	Change the channels used by own station or the target station's channel in the control data.
D25DH	The transient data is incorrect.	<ul style="list-style-type: none"> Correct the transient data at the request source, and retry the operation. If the error occurs again even after taking the above action, please consult your local Mitsubishi representative.
D26BH	The network number setting of the CCPASET instruction execution station is incorrect.	Set "Network Number" under "Network Number" of "Required Settings" to a value within 1 to 239.
D280H	The request command of transient transmission is incorrect.	Correct the request command at the request source, and retry the operation.
D281H	Transient reception failed.	<ul style="list-style-type: none"> Check the network status using the CC-Link IE Field Network diagnostics of the engineering tool, and take action. When the target station or the relay station is overloaded and cannot receive transient data, send the data to the target/relay station after the load on the station is reduced.
D282H	The receive queue is full.	<ul style="list-style-type: none"> Pause the transient transmission temporarily, and retry the operation. Lower the transient transmission usage frequency, and then perform again. If the error occurs again even after taking the above action, please consult your local Mitsubishi representative.
D283H	Transient transmission failed.	<ul style="list-style-type: none"> Check the network status using the CC-Link IE Field Network diagnostics of the engineering tool, and take action. Connect the cable to the other port on the request source, and retry the operation. Lower the transient transmission usage frequency, and then perform again.
D284H	The target execution module in the SLMP data is incorrect.	Correct the target execution module in the SLMP header, and retry the operation.

Error code	Error details and causes	Action
D2A0H	The receive buffer is full.	<ul style="list-style-type: none"> • Check the network status using the CC-Link IE Field Network diagnostics of the engineering tool, and take action. • When the target station or the relay station is overloaded and cannot receive transient data, send the data to the target/relay station after the load on the station is reduced.
D2A1H	The send buffer is full.	<ul style="list-style-type: none"> • Lower the transient transmission usage frequency, and then perform again. • Check if the switching hub and the cables at the request source are connected properly.
D2A2H	Transmission completion wait timeout has occurred in transient transmission.	<ul style="list-style-type: none"> • Lower the transient transmission usage frequency, and then perform again. • When "Communication Mode" in "Application Settings" of the master station (submaster station) is set to "High-Speed", change it to "Normal" and retry the operation. • Check if the switching hub and the cables at the request source are connected properly. • Correct the number of link dedicated instructions that have been simultaneously executed within the range.
D2A3H	The data length in the transient transmission frame is incorrect.	Correct the number of data (frame length) at the request source, and retry the operation.
D2A4H	The header information in the transient transmission frame is incorrect.	Correct the header information at the request source, and retry the operation.
D2A5H	The target station number in the transient transmission frame is incorrect.	Correct the target station number at the request source, and retry the operation.
D2A6H	The request source number in the transient transmission frame is incorrect.	Correct the request source number at the request source, and retry the operation.
D2A7H	The header information in the transient transmission frame is incorrect.	Correct the header information at the request source, and retry the operation.
D2A8H	The header information in the transient transmission frame is incorrect.	Correct the header information at the request source, and retry the operation.
D2A9H	The target network number in the transient transmission frame is incorrect.	Correct the target network number at the request source, and retry the operation.
D2AAH	The target station number in the transient transmission frame is incorrect.	Correct the target station number at the request source, and retry the operation.
D2ABH	The request source network number in the transient transmission frame is incorrect.	Correct the network number of the request source at the request source, and retry the operation.
D2ACH	The request source station number in the transient transmission frame is incorrect.	Correct the station number of the request source at the request source, and retry the operation.
D2ADH	The data length in the transient transmission frame is incorrect.	Correct the number of data (frame length) at the request source, and retry the operation.
D2AEH	The target station number in the transient transmission frame is incorrect.	The own station received transient data addressed to another station. Correct the network and target station numbers, and retry the operation.
D2AFH	The own station number was specified as the target station number of transient transmission.	Transient data transmission addressed to the own station was requested. Check the network number and target station number, and retry the operation.
D2B0H	Transient transmission failed.	<ul style="list-style-type: none"> • Check if the switching hub and the cables at the request source are connected properly. • Connect the cable to the other port on the request source, and retry the operation. • Lower the transient transmission usage frequency, and then perform again.
D2B1H	The receive queue is full.	<ul style="list-style-type: none"> • Pause the transient transmission temporarily, and retry the operation. • Lower the transient transmission usage frequency, and then perform again. • If the error occurs again even after taking the above action, please consult your local Mitsubishi representative.
D605H	A network parameter error was detected.	<ul style="list-style-type: none"> • Write the network parameters to the CPU module again. • If the error occurs again even after taking the above action, please consult your local Mitsubishi representative.
D606H	A network parameter error was detected.	<ul style="list-style-type: none"> • Write the network parameters to the CPU module again. • If the error occurs again even after taking the above action, please consult your local Mitsubishi representative.
D607H	A network parameter error was detected.	<ul style="list-style-type: none"> • Write the network parameters to the CPU module again. • If the error occurs again even after taking the above action, please consult your local Mitsubishi representative.
D609H	A network parameter error was detected.	<ul style="list-style-type: none"> • Write the network parameters to the CPU module again. • If the error occurs again even after taking the above action, please consult your local Mitsubishi representative.
D60DH	An error was detected in the network module.	<ul style="list-style-type: none"> • Take measures to reduce noise. • Execute the module communication test. If the error occurs again even after taking the above action, hardware failure is a possible cause. Consult your local Mitsubishi Electric representative.

Error code	Error details and causes	Action
D60EH	An error was detected in the network module.	<ul style="list-style-type: none"> • Take measures to reduce noise. • Execute the module communication test. If the error occurs again even after taking the above action, hardware failure is a possible cause. Consult your local Mitsubishi Electric representative.
D60FH	An error was detected in the network module.	<ul style="list-style-type: none"> • Take measures to reduce noise. • Execute the module communication test. If the error occurs again even after taking the above action, hardware failure is a possible cause. Consult your local Mitsubishi Electric representative.
D610H	An error was detected in the network module.	<ul style="list-style-type: none"> • Take measures to reduce noise. • Execute the module communication test. If the error occurs again even after taking the above action, hardware failure is a possible cause. Consult your local Mitsubishi Electric representative.
D62AH	A network parameter error was detected.	<ul style="list-style-type: none"> • Write the network parameters to the CPU module again. • Correct the data link faulty station setting, and retry the operation. • If the error occurs again even after taking the above action, please consult your local Mitsubishi representative.
D62BH	A network parameter error was detected.	<ul style="list-style-type: none"> • Write the network parameters to the CPU module again. • Correct the output status setting for CPU STOP, and retry the operation. • If the error occurs again even after taking the above action, please consult your local Mitsubishi representative.
D62DH	Data link start failed.	<p>Remove any of the following causes, and retry the operation.</p> <ul style="list-style-type: none"> • Station number unassigned • CPU module error on the own station • Station type mismatch • Master station lost • Station number of the own station out of the range • Own station number duplication • Own station reserved • Parameter error • Parameter communication in progress • Parameter not received • Link stop instruction
D637H	The UINI instruction was executed at a station where the station number has been already set by parameter.	Execute again after setting "Setting Method" under "Station Number" in "Required Settings" to "Program".
D639H	After setting a station number with the UINI instruction, the instruction was executed again.	Station number setting with the UINI instruction is limited to one time only. Execute again after resetting the CPU module.
D721H	Link start/stop was requested from another station during link start/stop processing.	Retry the operation after the stop or restart of data link is completed.
D722H	Link start/stop was requested from the own station during link start/stop processing.	Retry the operation after the stop or restart of data link is completed.
D726H	The request command of transient transmission is incorrect.	Correct the request command at the request station, and retry the operation.
D727H	Link start was requested from a station other than the station which had requested link stop.	<ul style="list-style-type: none"> • Data link start was instructed from a station different from the one that had instructed the data link stop. Instruct data link start and data link stop from the same station. • The method of the data link start differs from that of the data link stop. Instruct the data link start using the same method as the data link stop. (Ex. Data link is stopped using the CC-Link IE Field Network diagnostics, and the data link is started using a program.) • Data link start has failed. Forcibly restart the data link.
D728H	Data link startup instruction was executed to the station which is performing data link.	Execute the data link startup instruction to the station where data link had been stopped.
D729H	Link stop of the own station was instructed in the station with no station number setting.	Specify the station number using the UINI instruction, and execute the instruction again.
D800H	An error was detected in the network module.	<ul style="list-style-type: none"> • Take measures to reduce noise. • Execute the module communication test. If the error occurs again even after taking the above action, hardware failure is a possible cause. Consult your local Mitsubishi Electric representative.
D806H	The receive queue is full.	<ul style="list-style-type: none"> • Lower the transient transmission usage frequency, and then perform again. • Check if the switching hub and the cables are connected properly.
D807H	An error was detected in the network module.	<ul style="list-style-type: none"> • Take measures to reduce noise. • Execute the module communication test. If the error occurs again even after taking the above action, hardware failure is a possible cause. Consult your local Mitsubishi Electric representative.

Error code	Error details and causes	Action
D80AH	A network parameter error was detected.	<ul style="list-style-type: none"> Write the network parameters to the CPU module again. If the error occurs again even after taking the above action, please consult your local Mitsubishi representative.
D80BH	A network parameter error was detected.	<ul style="list-style-type: none"> Write the network parameters to the CPU module again. If the error occurs again even after taking the above action, please consult your local Mitsubishi representative.
D80CH	A network parameter error was detected.	<ul style="list-style-type: none"> Write the network parameters to the CPU module again. If the error occurs again even after taking the above action, please consult your local Mitsubishi representative.
D80DH	A network parameter error was detected.	<ul style="list-style-type: none"> Write the network parameters to the CPU module again. If the error occurs again even after taking the above action, please consult your local Mitsubishi representative.
D80EH	A network parameter error was detected.	<ul style="list-style-type: none"> Write the network parameters to the CPU module again. If the error occurs again even after taking the above action, please consult your local Mitsubishi representative.
D80FH	A network parameter error was detected.	<ul style="list-style-type: none"> Write the network parameters to the CPU module again. If the error occurs again even after taking the above action, please consult your local Mitsubishi representative.
D812H	A network parameter error was detected.	<ul style="list-style-type: none"> Write the network parameters to the CPU module again. If the error occurs again even after taking the above action, please consult your local Mitsubishi representative.
D813H	A network parameter error was detected.	<ul style="list-style-type: none"> Write the network parameters to the CPU module again. If the error occurs again even after taking the above action, please consult your local Mitsubishi representative.
D814H	An error was detected in the network module.	<ul style="list-style-type: none"> Take measures to reduce noise. Execute the module communication test. If the error occurs again even after taking the above action, hardware failure is a possible cause. Consult your local Mitsubishi Electric representative.
D816H	An error was detected in the network module.	<ul style="list-style-type: none"> Take measures to reduce noise. Execute the module communication test. If the error occurs again even after taking the above action, hardware failure is a possible cause. Consult your local Mitsubishi Electric representative.
D819H	An error occurred in the CPU module.	<ul style="list-style-type: none"> Replace the CPU module. If the error occurs again even after taking the above action, please consult your local Mitsubishi representative.
D81AH	A stop error occurred in the CPU module.	Check the error and take action in "Module Diagnostics" of the engineering tool.
D827H	The communication RAM is incorrect.	<ul style="list-style-type: none"> Take measures to reduce noise. Execute the module communication test. If the error occurs again even after taking the above action, hardware failure is a possible cause. Consult your local Mitsubishi Electric representative.
D902H	The online test data is incorrect.	<ul style="list-style-type: none"> Correct the data at the station that started the online test, and retry the operation. If the error occurs again even after taking the above action, please consult your local Mitsubishi representative.
D90DH	During execution of the cable test, the test was retried.	After completion of the cable test, retry the operation.
DA00H	An error was detected in the network module.	<ul style="list-style-type: none"> Take measures to reduce noise. Execute the module communication test. If the error occurs again even after taking the above action, hardware failure is a possible cause. Consult your local Mitsubishi Electric representative.
DA01H	An error was detected in the network module.	<ul style="list-style-type: none"> Take measures to reduce noise. Execute the module communication test. If the error occurs again even after taking the above action, hardware failure is a possible cause. Consult your local Mitsubishi Electric representative.
DA10H	An error was detected in the network module.	<ul style="list-style-type: none"> Take measures to reduce noise. Execute the module communication test. If the error occurs again even after taking the above action, hardware failure is a possible cause. Consult your local Mitsubishi Electric representative.
DA11H	An error was detected in the network module.	<ul style="list-style-type: none"> Take measures to reduce noise. Execute the module communication test. If the error occurs again even after taking the above action, hardware failure is a possible cause. Consult your local Mitsubishi Electric representative.

10.6 List of Parameter Numbers

This section lists the parameter numbers displayed in the module diagnostics.

Item			Parameter No.	
Required Settings	Station Type	Station Type	7700H	
	Network Number	Network Number	7100H	
	Station Number	Setting Method	7100H	
		Station No.	7100H	
Parameter Setting Method	Setting Method of Basic/Application Settings		7100H	
Basic Settings	Refresh Setting		7401H	
Application Settings	Supplementary Cyclic Settings	I/O Maintenance Settings	Output Hold/Clear Setting during CPU STOP	A050H
			Data Link Error Station Setting	A050H
			Output Mode upon CPU Error	7101H
	Interrupt Settings			A014H
	Parameter Name			7311H
	Module Operation Mode			7100H

APPENDIX

Appendix 1 Standards

Certification of UL, cUL standards

The FX5-CCLIEF supports UL (UL, cUL) standards.
For models that support UL standards, refer to the following.
UL, cUL file number: E95239

Compliance with EC directive (CE Marking)

This note does not guarantee that an entire machine produced in accordance with the contents of this note will comply with the following standards.
Compliance to EMC directive and LVD directive of the entire mechanical module should be checked by the user/ manufacturer. For more details please contact to the local Mitsubishi Electric sales site.

Requirement for compliance with EMC directive

The following products have shown compliance through direct testing (of the identified standards below) and design analysis (through the creation of a technical construction file) to the European Directive for Electromagnetic Compatibility (2014/30/ EU) when used as directed by the appropriate documentation.

Attention

This product is designed for use in industrial applications.

Product compatibility

Type: Programmable controller (open type equipment)
Models: FX5 manufactured

Electromagnetic compatibility (EMC) directive	Remarks
from May 1st, 2016 FX5-CCLIEF EN61131-2:2007 Programmable controllers - Equipment requirements and tests	Compliance with all relevant aspects of the standard. EMI • Radiated emission • Conducted emission EMS • Radiated electromagnetic field • Fast transient burst • Electrostatic discharge • High-energy surge • Voltage drops and interruptions • Conducted RF • Power frequency magnetic field

Caution for compliance with EC Directive

Caution for when the FX5-CCLIEF is used

When the FX5-CCLIEF is used, attach a ferrite core and make 3 turns within approximately 200 mm from the power cable connectors. (Ferrite core used in tests by Mitsubishi: ZCAT3035-1330 manufactured by TDK Co.)

Caution for when the Ethernet port is used

- Use a shielded twisted pair cable for the 1000BASE-T cable. Strip a part of the jacket of the shielded twisted pair cable as shown below and ground as much of the exposed shield as possible to both sides of the cable.
- Attach a ferrite core and make 1 turn at both ends of the cable. (Ferrite core used in tests by Mitsubishi: ZCAT3035-1330 manufactured by TDK Co.)

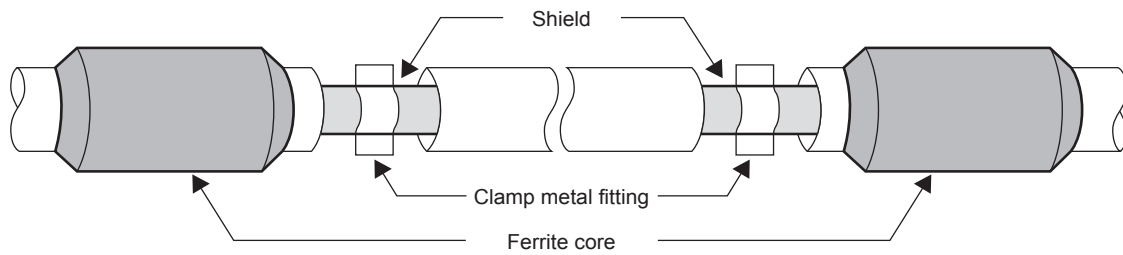

Noise filter (power supply line filter)

- Fit a noise filter onto the power supply cable. (Noise filter: TDK-Lambda RSHN-2020 was used for Mitsubishi's test.)
- Separate the input cable (power source side) away from the output cable (device side). If the input cable and output cable are bundled together or laid close to each other, noise from the output cable may be induced to the input cable where noise is removed by the noise filter. Ground the noise filter with the shortest possible grounding cable.

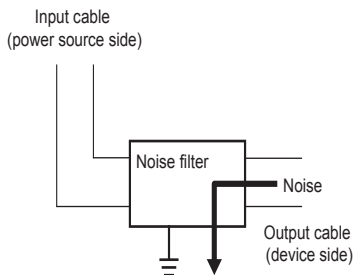

Appendix 2 Buffer Memory

The buffer memory is used to exchange data between the FX5-CCLIEF and the FX5 CPU module. Buffer memory values are reset to default when the FX5 CPU module is reset or the system is powered off.

List of buffer memory addresses

Address (decimal)	Address (hexadecimal)	Name		Read, write
0 to 23	0000H to 0017H	Link device area	Remote input (RX)	Read, write
24 to 1023	0018H to 03FFH		Not used	
1024 to 1047	0400H to 0417H		Remote output (RY)	Read
1048 to 2047	0418H to 07FFH		Not used	
2048 to 3071	0800H to 0BFFH		Remote register (RWw)	Read
3072 to 10239	0C00H to 27FFH		Not used	
10240 to 11263	2800H to 2BFFH		Remote register (RWr)	Read, write
11264 to 18431	2C00H to 47FFH		Not used	
18432 to 18463	4800H to 481FH		Link special relay (SB)	<ul style="list-style-type: none"> • 18432 to 18434 for read and write • 18435 to 18463 for read only
18464 to 18975	4820H to 4A1FH		Link special register (SW)	<ul style="list-style-type: none"> • 18464 to 18511 for read and write • 18512 to 18975 for read only
18976 to 20511	4A20H to 501FH	System area		
20512	5020H	Own station information	Manufacturer code	Read
20513	5021H		Model type	Read
20514	5022H		Model code	Read
20515	5023H		Version	Read
20516 to 32767	5024H to 7FFFH	System area		

Point

- Do not write data to "System area". Doing so may cause malfunction of the programmable controller system.
- If the value in an area of one word in size becomes equal to or higher than 65536, the count stops at 65535 (FFFFH).

Details of buffer memory addresses

Link device area

The RX, RY, RWw, and RWr values are stored.

■Remote input (RX) (Un\G0 to Un\G23)

The RX value is stored.

Address	b15	b14	b13	b12	b11	b10	b9	b8	b7	b6	b5	b4	b3	b2	b1	b0
Un\G0	RXF	RXE	RXD	RXC	RXB	RXA	RX9	RX8	RX7	RX6	RX5	RX4	RX3	RX2	RX1	RX0
⋮																
Un\G23	RX17 F	RX17 E	RX17 D	RX17 C	RX17 B	RX17 A	RX17 9	RX17 8	RX17 7	RX17 6	RX17 5	RX17 4	RX17 3	RX17 2	RX17 1	RX17 0

Each bit corresponds to 1 bit of RX.

■Remote output (RY) (Un\G1024 to Un\G1047)

The RY value is stored.

Address	b15	b14	b13	b12	b11	b10	b9	b8	b7	b6	b5	b4	b3	b2	b1	b0
Un\G1024	RYF	RYE	RYD	RYC	RYB	RYA	RY9	RY8	RY7	RY6	RY5	RY4	RY3	RY2	RY1	RY0
⋮																
Un\G1047	RY17 F	RY17 E	RY17 D	RY17 C	RY17 B	RY17 A	RY17 9	RY17 8	RY17 7	RY17 6	RY17 5	RY17 4	RY17 3	RY17 2	RY17 1	RY17 0

Each bit corresponds to 1 bit of RY.

■Remote register (RWw) (Un\G2048 to Un\G3071)

The RWw value is stored.

Address	b15	b14	b13	b12	b11	b10	b9	b8	b7	b6	b5	b4	b3	b2	b1	b0
Un\G2048	RWw0															
Un\G2049	RWw1															
⋮																
Un\G3071	RWw3FF															

■Remote register (RWr) (Un\G10240 to Un\G11263)

The RWr value is stored.

Address	b15	b14	b13	b12	b11	b10	b9	b8	b7	b6	b5	b4	b3	b2	b1	b0
Un\G10240	RWr0															
Un\G10241	RWr1															
⋮																
Un\G11263	RWr3FF															

■Link special relay (SB) (Un\G18432 to Un\G18463)

The SB value is stored.

Address	b15	b14	b13	b12	b11	b10	b9	b8	b7	b6	b5	b4	b3	b2	b1	b0
Un\G18432	SBF	SBE	SBD	SBC	SBB	SBA	SB9	SB8	SB7	SB6	SB5	SB4	SB3	SB2	SB1	SB0
⋮																
Un\G18463	SB1F F	SB1F E	SB1F D	SB1F C	SB1F B	SB1F A	SB1F 9	SB1F 8	SB1F 7	SB1F 6	SB1F 5	SB1F 4	SB1F 3	SB1F 2	SB1F 1	SB1F 0

Each bit corresponds to 1 bit of SB.



■Link special register (SW) (Un\G18464 to Un\G18975)

The SW value is stored.

Address	b15	b14	b13	b12	b11	b10	b9	b8	b7	b6	b5	b4	b3	b2	b1	b0
Un\G18464	SW0															
Un\G18465	SW1															
:																
Un\G18975	SW1FF															

Own station information

The information of the own station on the network is stored.

■Own station (network card) information (Un\G20512 to Un\G20515)

Address	Name	Description
Un\G20512	Manufacturer code	Stores own station information.
Un\G20513	Model type	
Un\G20514	Model code	
Un\G20515	Version	

Appendix 3 List of Link Special Relay (SB)

The link special relay (SB) is turned on/off depending on various factors during data link. Any error status of the data link can be checked by using or monitoring it in the program.

Application of link special relay (SB)

By using link special relay (SB), the status of CC-Link IE Field Network can be checked from HMI (Human Machine Interfaces) as well as the engineering tool.

Refresh of link special relay (SB)

To use link special relay (SB), set them in "Refresh Setting" in the parameter so that they are refreshed to the devices of the FX5 CPU module. (☞ Page 38 Refresh setting)

Ranges turned on/off by users and by the system

The following ranges correspond to when the link special relay areas (SB) are assigned from SB0000 to SB01FF.

- Turned on/off by users: SB0000 to SB001F
- Turned on/off by the system: SB0020 to SB01FF

List of link special relay (SB)

The following table lists the link special relay areas (SB) when they are assigned from SB0000 to SB01FF.



Do not turn on or off areas whose numbers are not on the list of link special relay (SB). Doing so may cause malfunction of the programmable controller system.

No.	Name	Description
SB0000	Link startup of own station	Starts data link (cyclic transmission) of the own station. Off : Startup not requested On : Startup requested (valid at rising edge) (Conditions) • This relay is enabled when 'Baton pass status of own station' (SB0047) is off. • For SB0000 to SB0001, only one of the areas can be turned on.
SB0001	Link stop of own station	Stops data link (cyclic transmission) of the own station. Off : Stop not requested On : Stop requested (valid at rising edge) (Conditions) • This relay is enabled when 'Baton pass status of own station' (SB0047) is off. • For SB0000 to SB0001, only one of the areas can be turned on.
SB0006	Clear communication error count	Clears the link special register areas related to communication errors (SW0068 to SW006B, SW0074 to SW0077, SW007C to SW007F) to 0. Off : Clear not requested On : Clear requested (valid while on)
SB0030	RECV instruction execution request flag CH1	Stores the data reception status of own station channel 1. Off : No data received On : Data received (Conditions) • This relay is enabled when 'Baton pass status of own station' (SB0047) is off. • When 'Baton pass status of own station' (SB0047) is turned on (error), data prior to error is held.
SB0031	RECV instruction execution request flag CH2	Stores the data reception status of own station channel 2. Off : No data received On : Data received (Conditions) • This relay is enabled when 'Baton pass status of own station' (SB0047) is off. • When 'Baton pass status of own station' (SB0047) is turned on (error), data prior to error is held.
SB0040	Network type of own station	Stores the network type of the own station. On : CC-Link IE Field Network
SB0043	Module operation mode of own station	Stores the module operation mode of the own station. Off : Online mode On : Other than online mode

No.	Name	Description
SB0046	Station number setting status of own station	Stores the station number setting status. Off : Station number set On : Station number not set If parameters are set using the engineering tool, this relay is always OFF.
SB0047	Baton pass status of own station	Stores the baton pass status (transient transmission availability) of the own station. Off : Normal On : Error When this relay is turned on, the cause of the error can be checked with 'Baton pass status of own station' (SW0047) and 'Cause of baton pass interruption' (SW0048). Depending on the link refresh timing, the update of 'Baton pass status of own station' (SW0047) and 'Cause of baton pass interruption' (SW0048) may be offset by one sequence scan.
SB0049	Data link error status of own station	Stores the data link error status of the own station. Off : Normal On : Error When this relay is turned on, the cause of the error can be checked with 'Cause of data link stop' (SW0049). Depending on the link refresh timing, the update of 'Cause of data link stop' (SW0049) may be offset by one sequence scan. (Conditions) • This relay is enabled when 'Baton pass status of own station' (SB0047) is off. • When 'Baton pass status of own station' (SB0047) is turned on (error), data prior to error is held.
SB004A	CPU minor error status of own station	Stores the minor error occurrence status of the CPU module on the own station. Off : No minor error On : Minor error
SB004B	CPU moderate/major error status of own station	Stores the moderate/major error occurrence status of the CPU module on the own station. Off : No moderate/major error On : Moderate/major error
SB004C	CPU operating status of own station	Stores the operating status of the CPU module on the own station. Off : RUN On : STOP, PAUSE, or moderate/major error
SB004D	Received parameter error	Stores the status of received parameter. Off : Normal On : Error
SB004F	Station number status of the operating station	Stores the setting method of the station number set. Off : Set by parameters On : Set by program
SB0050	Link startup request accept status of own station	Stores the acceptance status of 'Link startup of own station' (SB0000). Off : Not accepted (SB0000 is off.) On : Accepted (SB0000 is on.) (Conditions) • This relay is enabled when 'Baton pass status of own station' (SB0047) is off. • When 'Baton pass status of own station' (SB0047) is turned on (error), data prior to error is held.
SB0051	Link startup completion status of own station	Stores the status of link startup processing requested with 'Link startup of own station' (SB0000). Off : Link startup not completed (SB0000, SB0050 are off.) On : Link startup completed (SB0000, SB0050 are on.) (Conditions) • This relay is enabled when 'Baton pass status of own station' (SB0047) is off. • When 'Baton pass status of own station' (SB0047) is turned on (error), data prior to error is held.
SB0052	Link stop request accept status of own station	Stores the acceptance status of 'Link stop of own station' (SB0001). Off : Not accepted (SB0001 is off.) On : Accepted (SB0001 is on.) (Conditions) • This relay is enabled when 'Baton pass status of own station' (SB0047) is off. • When 'Baton pass status of own station' (SB0047) is turned on (error), data prior to error is held.
SB0053	Link stop completion status of own station	Stores the link stop processing status requested with 'Link stop of own station' (SB0001). Off : Not completed (SB0001, SB0052 are off.) On : Completed (SB0001, SB0052 are on.) (Conditions) • This relay is enabled when 'Baton pass status of own station' (SB0047) is off. • When 'Baton pass status of own station' (SB0047) is turned on (error), data prior to error is held.
SB006A	PORT1 link-down status of own station	Stores the link down status of the own station P1 side. Off : Link-up On : Link-down The time that link-up starts after power-on or Ethernet cable connection may vary. Normally link-up takes several seconds. Depending on device status on the line, link-up processing may be repeated, resulting in longer link-up time.

No.	Name	Description
SB006B	PORT2 link-down status of own station	Stores the link down status of the own station P2 side. Off : Link-up On : Link-down The time that link-up starts after power-on or Ethernet cable connection may vary. Normally link-up takes several seconds. Depending on device status on the line, link-up processing may be repeated, resulting in longer link-up time.
SB006C	PORT1 current error frame reception status of own station	Stores whether the error frame is currently received at the P1 side of the own station. Off : Not received On : Currently receiving
SB006D	PORT2 current error frame reception status of own station	Stores whether the error frame is currently received at the P2 side of the own station. Off : Not received On : Currently receiving
SB006E	PORT1 error frame detection of own station	Stores whether the error frame was received at the P1 side of the own station from power-on to the present. Off : Not received On : Received
SB006F	PORT2 error frame detection of own station	Stores whether the error frame was received at the P2 side of the own station from power-on to the present. Off : Not received On : Received
SB007B	Input data status of data link faulty station	Stores the setting status in "Data Link Error Station Setting" of the own station. Off : Clear On : Hold
SB007D	Hold/clear status setting for CPU STOP	Stores the setting status in "Output Setting During CPU STOP" of the own station. Off : Hold On : Clear
SB00A1	Baton pass error status of master station	Stores the baton pass status of the master station (master operating station). Off : Normal On : Error (Conditions) • This relay is enabled when 'Baton pass status of own station' (SB0047) is off. • When 'Baton pass status of own station' (SB0047) is turned on (error), data prior to error is held.
SB00B1	Data link error status of master station	Stores the data link status of the master station (master operating station). Off : Normal On : Error (Conditions) • This relay is enabled when 'Baton pass status of own station' (SB0047) is off. • When 'Baton pass status of own station' (SB0047) is turned on (error), data prior to error is held.
SB00F1	CPU operating status of master station	Stores the operating status of the CPU module on the master station (master operating station). Off : RUN or STEP-RUN state On : STOP state, PAUSE state, or moderate/major error (Conditions) • This relay is enabled when 'Baton pass status of own station' (SB0047) is off. • When 'Baton pass status of own station' (SB0047) is turned on (error), data prior to error is held.
SB0101	CPU moderate/major error status of master station	Stores the moderate/major error occurrence status of the CPU module on the master station (master operation station). Off : No moderate/major error On : Moderate/major error (Conditions) • This relay is enabled when 'Baton pass status of own station' (SB0047) is off. • When 'Baton pass status of own station' (SB0047) is turned on (error), data prior to error is held.
SB0111	CPU minor error status of master station	Stores the minor error occurrence status of the CPU module on the master station (master operating station). Off : No minor errors, or a moderate/major error being occurred On : Minor error (Conditions) • This relay is enabled when 'Baton pass status of own station' (SB0047) is off. • When 'Baton pass status of own station' (SB0047) is turned on (error), data prior to error is held.
SB0121	PORT1 current error frame reception status of master station	Stores whether the error frame is currently received at the P1 side of the master station (master operating station). Off : Not received On : Currently receiving (Conditions) • This relay is enabled when 'Baton pass status of own station' (SB0047) is off. • When 'Baton pass status of own station' (SB0047) is turned on (error), data prior to error is held.

No.	Name	Description
SB0131	PORT2 current error frame reception status of master station	Stores whether the error frame is currently received at the P2 side of the master station (master operating station). Off : Not received On : Currently receiving (Conditions) • This relay is enabled when 'Baton pass status of own station' (SB0047) is off. • When 'Baton pass status of own station' (SB0047) is turned on (error), data prior to error is held.
SB0141	PORT1 error frame detection of master station	Stores whether the error frame was received at the P1 side of the master station (master operating station) from power-on to the present. Off : Not received On : Received (Conditions) • This relay is enabled when 'Baton pass status of own station' (SB0047) is off. • When 'Baton pass status of own station' (SB0047) is turned on (error), data prior to error is held.
SB0151	PORT2 error frame detection of master station	Stores whether the error frame was received at the P2 side of the master station (master operating station) from power-on to the present. Off : Not received On : Received (Conditions) • This relay is enabled when 'Baton pass status of own station' (SB0047) is off. • When 'Baton pass status of own station' (SB0047) is turned on (error), data prior to error is held.

Appendix 4 List of Link Special Register (SW)

The link special register (SW) stores the information during data link as a numerical value. Error locations and causes can be checked by using or monitoring the link special register (SW) in programs.

Application of link special register (SW)

By using link special register (SW), the status of CC-Link IE Field Network can be checked from HMI (Human Machine Interfaces) as well as the engineering tool.

Refresh of link special register (SW)

To use link special register (SW), set them in "Refresh Setting" under "Basic Settings" so that they are refreshed to the devices of the FX5 CPU module. (🔗 Page 38 Refresh setting)

Range where data are stored by users and range where data are stored by the system

The following ranges are allocated when the link special register areas (SW) are assigned from SW0000 to SW01FF.

- Stored by users: SW0000 to SW001F
- Stored by the system: SW0020 to SW01FF

List of link special register (SW)

The following table lists the link special register areas (SW) when they are assigned from SW0000 to SW01FF.



Do not write any data to an area whose number is not on the list of link special register (SW). Doing so may cause malfunction of the programmable controller system.

No.	Name	Description
SW0030	Link dedicated instructions processing result CH1	Stores the processing results of the link dedicated instruction that used channel 1 of the own station. 0: Completed normally 1 or greater: Completed with an error (Error code is stored.)
SW0031	Link dedicated instructions processing result CH2	Stores the processing results of the link dedicated instruction that used channel 2 of the own station. 0: Completed normally 1 or greater: Completed with an error (Error code is stored.)
SW0040	Network number	Stores the network number of the own station. Range: 1 to 239
SW0042	Station number	Stores the station number of the own station. Range: 1 to 120, 255 (station number unassigned)
SW0043	Mode status of own station	Stores the module operation mode setting or communication mode of the own station. 0: Online mode 2: Offline mode B: Module communication test mode
SW0046	Module type	Stores the hardware status of the own station. <div style="text-align: center;"> <p>SW0046 0 to 0</p> </div> Model type (b1, b0) 00: Module 01: Board 10: Display
SW0047	Baton pass status of own station	Stores the baton pass status (transient transmission availability) of the own station. 0: Data link in progress 2: Baton pass in progress 3: Baton pass being terminated 4: Test in progress 5: Offline

A

No.	Name	Description
SW0048	Cause of baton pass interruption	Stores the cause of interruption in the communication (baton pass) of the own station. 00H: At normal communication or power-on 30H: Cable disconnection 33H: Disconnection or return in progress 40H: Offline mode 41H: Module communication test
SW0049	Cause of data link stop	Stores the cause which stopped the data link of the own station. 00H: At normal communication or power-on 01H: Stop requested 02H: Monitoring time timeout 11H: Station number of the own station out of the range 12H: Reserved station setting of the own station 13H: Own station number duplication 16H: Station number unassigned 18H: Parameter error 19H: Parameter communication in progress 1AH: Station type mismatch 20H: CPU module moderate error, major error
SW004A	Data link stop request station	Stores the station number of the station that performed the data link stop request for the own station. Range: 125 (Master station) The data link stop request is performed by 'System link stop' (SB0003). (Conditions) • This register is enabled when 'Baton pass status of own station' (SB0047) is off. • When 'Baton pass status of own station' (SB0047) is turned on (error), data prior to error is held.
SW004B	CPU status of own station	Stores the status of the own station. 00H: No module mounted 01H: STOP (normal) 02H: STOP (moderate/major error) 03H: STOP (minor error) 04H: RUN (normal) 05H: RUN (minor error) 07H: PAUSE 0EH: Reset in progress 0FH: Initial processing
SW004C	Parameter setting status	Stores the status of parameter settings. 0: Normal 1 or greater: Error definition (Error code is stored.) (Conditions) • This register is enabled when 'Received parameter error' (SB004D) is on.
SW0050	Link startup result of own station	Stores the results when data link is started by 'Link startup of own station' (SB0000). 0: Normal 1 or greater: Error definition (Error code is stored.) When 'Link startup of own station' (SB0000) is turned off, the stored error definition is cleared. (Conditions) • This register is enabled when 'Baton pass status of own station' (SB0047) is off. • When 'Baton pass status of own station' (SB0047) is turned on (error), data prior to error is held.
SW0051	Link stop result of own station	Stores the results when data link is stopped by 'Link stop of own station' (SB0001). 0: Normal 1 or greater: Error definition (Error code is stored.) When 'Link stop of own station' (SB0001) is turned off, the stored error definition is cleared. (Conditions) • This register is enabled when 'Baton pass status of own station' (SB0047) is off. • When 'Baton pass status of own station' (SB0047) is turned on (error), data prior to error is held.
SW0064	Connection status of own station	Stores the connection status of the own station. 00H: Normal (communication in progress on P1 and P2) 01H: Normal (communication in progress on P1, cable disconnected on P2) 04H: Normal (loopback communication in progress on P1, cable disconnected on P2) 10H: Normal (cable disconnected on P1, communication in progress on P2) 11H: Disconnecting (cable disconnected on P1 and P2) 12H: Disconnecting (cable disconnected on P1, establishing line on P2) 21H: Disconnecting (establishing line on P1, cable disconnected on P2) 22H: Disconnecting (establishing line on P1 and P2) 40H: Normal (cable disconnected on P1, loopback communication in progress on P2)
SW0068	PORT1 line error occurrence rate maximum value	Stores the occurrence rate (maximum value) of received error frames at the P1 side of the own station. (Unit: %) When 'Clear communication error count' (SB0006) is turned on, the stored value for the occurrence rate is cleared.

No.	Name	Description
SW0069	PORT1 line error occurrence rate present value	Stores the occurrence rate (present value) of received error frames at the P1 side of the own station. (Unit: %) When 'Clear communication error count' (SB0006) is turned on, the stored value for the occurrence rate is cleared.
SW006A	PORT2 line error occurrence rate maximum value	Stores the occurrence rate (maximum value) of received error frames at the P2 side of the own station. (Unit: %) When 'Clear communication error count' (SB0006) is turned on, the stored value for the occurrence rate is cleared.
SW006B	PORT2 line error occurrence rate present value	Stores the occurrence rate (present value) of received error frames at the P2 side of the own station. (Unit: %) When 'Clear communication error count' (SB0006) is turned on, the stored value for the occurrence rate is cleared.
SW0074	PORT1 cable disconnection detection count	Stores the cumulative count that was detected for cable disconnections at the P1 side. When 'Clear communication error count' (SB0006) is turned on, the stored value for the number of errors is cleared. When FFFFH (maximum value 65535) is counted, the value returns to 0 and the module continues to count.
SW0075	PORT1 receive error detection count	Stores the cumulative count that error data was received at the P1 side. The count stores only error data that is not transmitted to all stations. When 'Clear communication error count' (SB0006) is turned on, the stored value for the number of errors is cleared. When FFFFH (maximum value 65535) is counted, counting stops.
SW0076	PORT1 total number of received data (lower 1 word)	Stores the cumulative count that data was received at the P1 side. When 'Clear communication error count' (SB0006) is turned on, the stored value for the number of errors is cleared. When FFFFFFFFH (maximum value 4294967295) is counted, counting stops.
SW0077	PORT1 total number of received data (upper 1 word)	
SW007C	PORT2 cable disconnection detection count	Stores the cumulative count that was detected for cable disconnections at the P2 side. When 'Clear communication error count' (SB0006) is turned on, the stored value for the number of errors is cleared. When FFFFH (maximum value 65535) is counted, the value returns to 0 and the module continues to count.
SW007D	PORT2 receive error detection count	Stores the cumulative count that error data was received at the P2 side. The count stores only error data that is not transmitted to all stations. When 'Clear communication error count' (SB0006) is turned on, the stored value for the number of errors is cleared. When FFFFH (maximum value 65535) is counted, counting stops.
SW007E	PORT2 total number of received data (lower 1 word)	Stores the cumulative count that data was received at the P2 side. When 'Clear communication error count' (SB0006) is turned on, the stored value for the number of errors is cleared. When FFFFFFFFH (maximum value 4294967295) is counted, counting stops.
SW007F	PORT2 total number of received data (upper 1 word)	



Appendix 5 Processing Time

I/O response time

The calculation formula for the response time of the intelligent device station is as follows:

$$Rio = (\text{Number of RX/RY points}) \times 0.16 + (\text{Number of RWw/RWr points}) \times 5.5 + 430 + Ka [\mu\text{s}]$$

The above formula calculates the average response time when auto refresh of the same number of points as the number of RX/RY and RWw/RWr points is performed.

- Rio: I/O response time of the intelligent device station
- Number of RX/RY points: The number of points set in "RX/RY Setting" of network configuration setting of the master station
- Number of RWw/RWr points: The number of points set in "RWw/RWr Setting" of network configuration setting of the master station
- Ka: The value to add when auto refresh of the intelligent function module is performed (=140)

FROM/TO processing time

For the processing time of the FROM/TO instruction, refer to the following manual.

 MELSEC iQ-F FX5 Programming Manual (Instructions, Standard Functions/Function Blocks)

Appendix 6 Added and Changed Functions

The functions added or changed with the FX5-CCLIEF and engineering tool, and supported firmware version of the FX5-CCLIEF and CPU module, and engineering tool software version are given below.

The firmware version of the FX5-CCLIEF can be confirmed with the system monitor. The firmware version of CPU module can be confirmed with module diagnosis (CPU diagnosis). For details, refer to the following manuals.

 GX Works3 Operating Manual

 MELSEC iQ-F FX5U User's Manual (Hardware)

 MELSEC iQ-F FX5UC User's Manual (Hardware)

Refer to the  GX Works3 Operating Manual for details on the software version.

FX5U/FX5UC CPU module

Add/Change Function	Supported version			Reference
	Firmware version of the CPU module	Firmware version of the FX5-CCLIEF	Engineering tool	
Firmware update function	"1.240" and above	"1.005" and above	"1.075D" and above	MELSEC iQ-F FX5 User's Manual (Application)

INDEX

0 to 9

32-bit data assurance 22

A

Access to devices and link devices 18
Automatic return 18

C

Cable test 18,117
Cascade connection 31
CC-Link IE Field Network diagnostics 18,114
Communications with different networks 18
Communications with the master station 18
Communications within the same network 18
Configuration in which data link cannot be performed
. 32
Cyclic data integrity assurance 18
Cyclic transmission program 105
Cyclic transmission stop and restart 18

D

Data link error station setting 40
Device Assignment Method 38
Diagnostic items 114
Diagnostics of own network 18
Diagnostics of the module 18

F

Firmware update function. 19

G

G(P).CCPASET 94
G(P).UINI 100
GP.READ 47
GP.RECV 88
GP.SEND 77
GP.SREAD 55
GP.SWRITE 70
GP.WRITE 61

I

I/O Maintenance Settings. 40
Input status setting for data link error. 18
Interlock program 22,23
Interrupt request to CPU module. 19
Interrupt Settings 40

L

Link dedicated instructions 44

M

Maximum number of link points per network 14
Mode selection for cyclic transmission 18
Module communication test 18,113
Module Operation Mode 40,43

N

Network Number 36
Network topology 30

O

Other dedicated instructions 45
Output hold/clear setting during CPU STOP 40
Output Mode upon CPU Error 40
Output status setting for CPU STOP 18
Output status setting for CPU stop error 18

P

Parameter Name 40,43
Parameter Setting Method 36

R

Refresh Setting 38
Remote operation 117

S

Selected station communication status monitor . . 116
SLMP communication 18
Station Number 36
Station number and connection position 31
Station number setting using a program 19
Station Type. 36
Station-based block data assurance 22
Supplementary Cyclic Settings 40

T

Transient transmission program 107

W

Wiring products 35

MEMO

REVISIONS

Revision date	Revision	Description
May 2016	A	First edition
October 2019	B	■Added models FX5UJ CPU module ■Added or modified parts SAFETY PRECAUTIONS, RELEVANT MANUALS, TERMS, Section 2.1, 2.2, 2.3, Chapter 3, Section 4.2, 6.2, 7.3, Chapter 8, Section 8.2, 8.3, 9.1, 10.4, Appendix 5, TRADEMARKS
August 2020	C	■Added or modified parts SAFETY PRECAUTIONS, WARRANTY
April 2021	D	■Added or modified parts RELEVANT MANUALS, TERMS, Section 4.1, Appendix 6, TRADEMARKS

This manual confers no industrial property rights or any rights of any other kind, nor does it confer any patent licenses. Mitsubishi Electric Corporation cannot be held responsible for any problems involving industrial property rights which may occur as a result of using the contents noted in this manual.

© 2016 MITSUBISHI ELECTRIC CORPORATION

WARRANTY

Please confirm the following product warranty details before using this product.

1. Gratis Warranty Term and Gratis Warranty Range

If any faults or defects (hereinafter "Failure") found to be the responsibility of Mitsubishi occurs during use of the product within the gratis warranty term, the product shall be repaired at no cost via the sales representative or Mitsubishi Service Company. However, if repairs are required onsite at domestic or overseas location, expenses to send an engineer will be solely at the customer's discretion. Mitsubishi shall not be held responsible for any re-commissioning, maintenance, or testing on-site that involves replacement of the failed module.

[Gratis Warranty Term]

The gratis warranty term of the product shall be for one year after the date of purchase or delivery to a designated place. Note that after manufacture and shipment from Mitsubishi, the maximum distribution period shall be six (6) months, and the longest gratis warranty term after manufacturing shall be eighteen (18) months. The gratis warranty term of repair parts shall not exceed the gratis warranty term before repairs.

[Gratis Warranty Range]

- (1) The range shall be limited to normal use within the usage state, usage methods and usage environment, etc., which follow the conditions and precautions, etc., given in the instruction manual, user's manual and caution labels on the product.
- (2) Even within the gratis warranty term, repairs shall be charged for in the following cases.
 1. Failure occurring from inappropriate storage or handling, carelessness or negligence by the user. Failure caused by the user's hardware or software design.
 2. Failure caused by unapproved modifications, etc., to the product by the user.
 3. When the Mitsubishi product is assembled into a user's device, Failure that could have been avoided if functions or structures, judged as necessary in the legal safety measures the user's device is subject to or as necessary by industry standards, had been provided.
 4. Failure that could have been avoided if consumable parts (battery, backlight, fuse, etc.) designated in the instruction manual had been correctly serviced or replaced.
 5. Relay failure or output contact failure caused by usage beyond the specified life of contact (cycles).
 6. Failure caused by external irresistible forces such as fires or abnormal voltages, and failure caused by force majeure such as earthquakes, lightning, wind and water damage.
 7. Failure caused by reasons unpredictable by scientific technology standards at time of shipment from Mitsubishi.
 8. Any other failure found not to be the responsibility of Mitsubishi or that admitted not to be so by the user.

2. Onerous repair term after discontinuation of production

- (1) Mitsubishi shall accept onerous product repairs for seven (7) years after production of the product is discontinued.
Discontinuation of production shall be notified with Mitsubishi Technical Bulletins, etc.
- (2) Product supply (including repair parts) is not available after production is discontinued.

3. Overseas service

Overseas, repairs shall be accepted by Mitsubishi's local overseas FA Center. Note that the repair conditions at each FA Center may differ.

4. Exclusion of loss in opportunity and secondary loss from warranty liability

Regardless of the gratis warranty term, Mitsubishi shall not be liable for compensation to:

- (1) Damages caused by any cause found not to be the responsibility of Mitsubishi.
- (2) Loss in opportunity, lost profits incurred to the user by Failures of Mitsubishi products.
- (3) Special damages and secondary damages whether foreseeable or not, compensation for accidents, and compensation for damages to products other than Mitsubishi products.
- (4) Replacement by the user, maintenance of on-site equipment, start-up test run and other tasks.

5. Changes in product specifications

The specifications given in the catalogs, manuals or technical documents are subject to change without prior notice.

6. Product application

- (1) In using the Mitsubishi MELSEC programmable controller, the usage conditions shall be that the application will not lead to a major accident even if any problem or fault should occur in the programmable controller device, and that backup and fail-safe functions are systematically provided outside of the device for any problem or fault.
- (2) The Mitsubishi programmable controller has been designed and manufactured for applications in general industries, etc. Thus, applications in which the public could be affected such as in nuclear power plants and other power plants operated by respective power companies, and applications in which a special quality assurance system is required, such as for railway companies or public service purposes shall be excluded from the programmable controller applications.
In addition, applications in which human life or property that could be greatly affected, such as in aircraft, medical applications, incineration and fuel devices, manned transportation, equipment for recreation and amusement, and safety devices, shall also be excluded from the programmable controller range of applications. However, in certain cases, some applications may be possible, providing the user consults their local Mitsubishi representative outlining the special requirements of the project, and providing that all parties concerned agree to the special circumstances, solely at the user's discretion.
- (3) Mitsubishi shall have no responsibility or liability for any problems involving programmable controller trouble and system trouble caused by DoS attacks, unauthorized access, computer viruses, and other cyberattacks.

TRADEMARKS

Anywire and AnyWireASLINK are either registered trademarks or trademarks of Anywire Corporation.

The company names, system names and product names mentioned in this manual are either registered trademarks or trademarks of their respective companies.

In some cases, trademark symbols such as [™] or [®] are not specified in this manual.

Manual number: JY997D64201D

Model: FX5-U-CCIEF-E

Model code: 09R733

When exported from Japan, this manual does not require application to the Ministry of Economy, Trade and Industry for service transaction permission.

MITSUBISHI ELECTRIC CORPORATION

HEAD OFFICE: TOKYO BUILDING, 2-7-3 MARUNOUCHI, CHIYODA-KU, TOKYO 100-8310, JAPAN

Specifications are subject to change without notice.